

Automation for a Changing World

Delta Machine Vision System DMV Series Applications

Contents

Electronics

3

Printed Circuit Board (PCB) positioning	3
Inspection of C-type buckle installed in fan motors	5
Inspection of injecting glue length for motor magnets	7
Inspection of SMT material direction	9
Resistor laser engraving result detection	11
Coil angle checking	13
Rotor alignment	15
Glass lens and zinc sheet alignment and adhesion	17

Semiconductors

19

IC positioning inspection	19
Inspection of damaged solar panels	21
Cell phone glass panel positioning	23
OCV inspection for laser engraving on semiconductors	25

Machine Tools

27

Ball dimple space measurement	27
Chamfering/radius R measurement	29
Bottle cap, label and water level inspection	31
OCV inspection on keys	33
SMT socket blockage inspection	35
Finished workpiece inspection	36
Inspection of workpiece in the terminal blocks	37
Metal workpiece quality inspection	39

Automotive

41

Inspection of automobile A/C buttons	41
Inspection of laser scribed electrical resistance in automobiles	43
Chromed trim inspection	45
Exhaust pipe inspection	47

Rubber & Plastics

49

Plastic bottle cap positioning	49
Rubber washer inspection	51
Inspection of self-tapping screw on a plastic workpiece	53
Plastic bottle and washer inspection	55

Packaging

57

Package barcode inspection	57
Coffee filter inspection	59
Inspection of face mask outer packages	61
Cosmetic sprayer inspection	63

Printing

65

Inspection of ink load for printing plates	65
Inspection of scratches on printed films	67
Inspection of printing quality on metal workpiece	69

Pharmaceuticals

71

Verification of expiration date (EXP) on medication bottles	71
Tablet quality inspection	73
Inspection of tag position on medication packaging	75

Other

77

Soldering spot coordinate identification on solar modules	77
Metal rivet inspection	79
Ceramic tile inspection	81
Inspection of the hollow direction on a metal workpiece	83

Electronics



Inspection Objectives

Printed Circuit Board (PCB) positioning

Using two cameras to locate a PCB from wide/narrow FOW

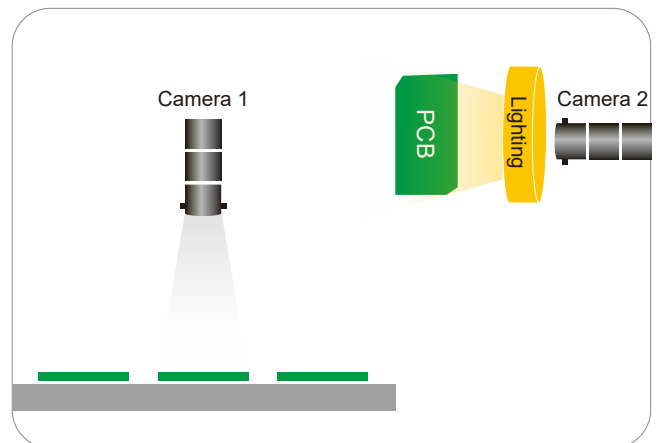

Device Configuration

Controller	DMV1000 (also applicable with DMV2000)		
Camera 1	DMV-CD80GS	Camera 2	DMV-CD80GS
Lens	12 mm focal length	Lens	12 mm focal length
Illumination	Backlight	Illumination	Front white ring light
Working distance	760 mm	Working distance	90 mm
FOV	300 mm x 225 mm	FOV	40 mm x 30 mm

【 Key Point 】

Use Camera 1 and 2 to locate and inspect a PCB:

- Camera 1 uses the "11-point learning" function to locate the PCBs inside the material tray, then uses the "Shape" function to guide the SCARA robot to pick up one of the PCBs
- Camera 2 uses the printed circuit of the PCB to operate the "Shape" function twice to obtain the X, Y and Θ coordinates and calculate the slight offset parameters for adjustment

【Result】

- Camera 1 is able to locate 10 pieces of PCBs' coordinates from a wide field of view (300 mm x 225 mm). The inspection time is within 500 ms, and the precision is 2 mm

(The figure shows 5 pieces of PCB for demonstration)

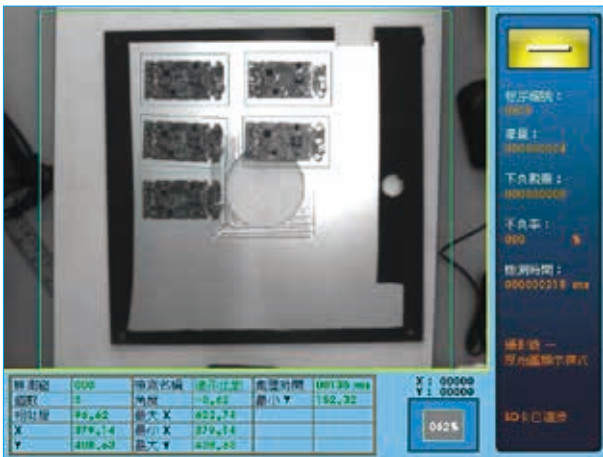

- Camera 2 inspects the position of the specific PCB for further processing with a narrowed field of view (40 mm x 30 mm). The inspection time is within 300 ms, and the precision is 0.1 mm

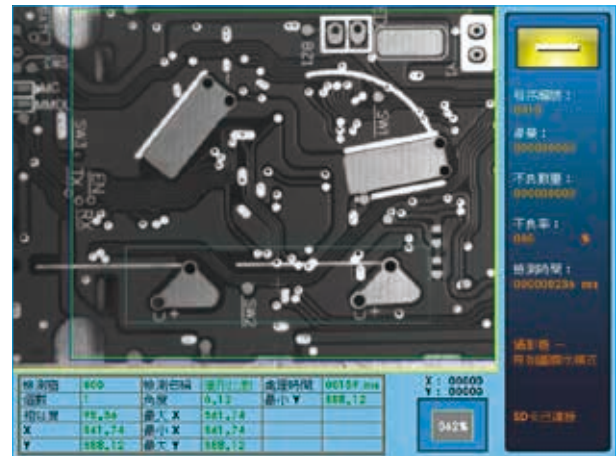

【Process】

- Camera 1 locates one of the PCBs, and the SCARA robot picks up the PCB according to the inspection results
- The SCARA robot moves the PCB to Camera 2 for a more specific positioning and places the PCB into the electrical tester

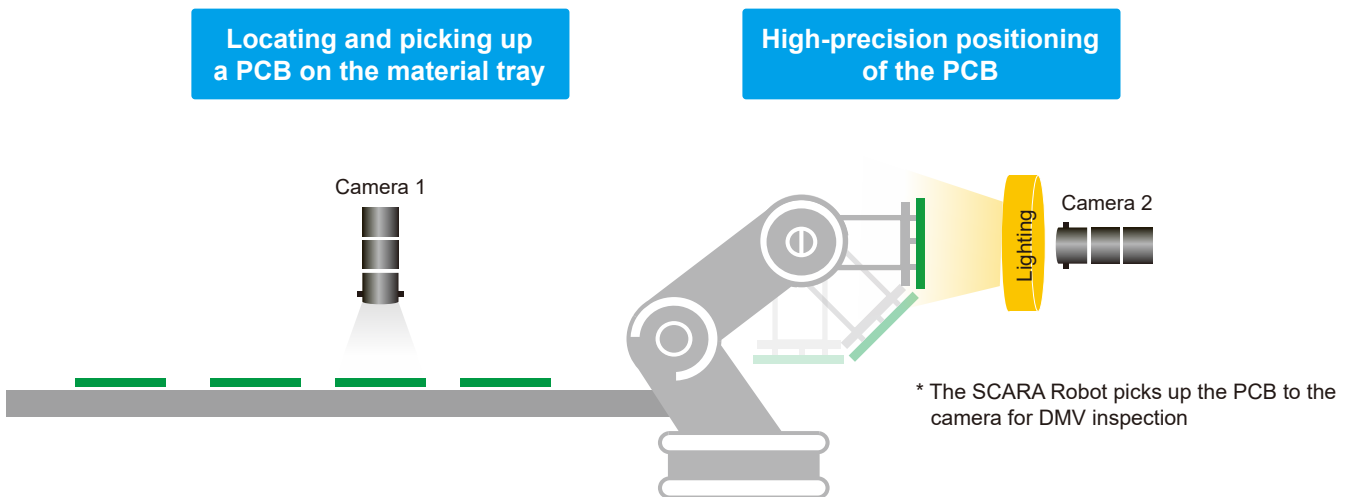

Advantages of the DMV system

Using two cameras, this application fulfills requirements for locating and precise positioning of PCBs from a wide / narrow field of view

Electronics

Inspection Objectives

Inspection of C-shape buckle installed in fan motors

Using the DMV Series to inspect the installation of the C-shape buckle on the fan

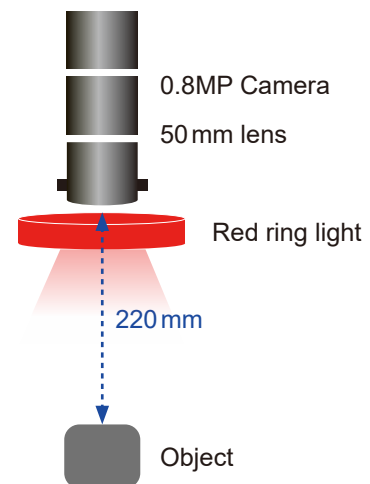

Device Configuration

Controller	DMV1000 (also applicable with DMV2000)
Camera	DMV-CD80GS
Lens	50 mm focal length
Illumination	Red ring light
Working distance	220 mm
FOV	16 mm x 12 mm

【 Inspecting Tool 】

Use the ring frame to locate inspection area, then use the "Edge Width" function to perform inspection

【 Key Point 】

Use the "Edge Width" function to inspect the two edges of the C-shape buckle, and calculate the angles. If the angle is too wide, it will be judged as an abnormal installation; if the result shows the angle difference is 0, it means the fan is not installed with any buckles

【Result】

- The angle difference of the two edges is 65.14, meaning the installation of the buckle is correct and the fan is judged as **OK**
- The angle difference of the two edges is 81.88, meaning the installation of the buckle is abnormal and the fan is judged as **NG**



- The angle difference of the two edges is 0, meaning the fan is without the buckle and judged as **NG**



【Process】

After the fan is installed with the C-shape buckle, the DMV Series will start to inspect. If the result shows OK, the fan will be sent to the next process; if NG, the fan will be removed

Advantages of the DMV system

This application fulfills the requirement for automatic inspection after assembly

Electronics



Inspection Objectives

Inspection of injecting glue length for motor magnets

Using the DMV Series to inspect the magnet and the gluing amount

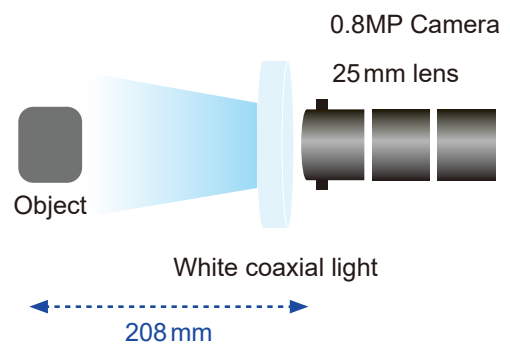

Device Configuration

Controller	DMV1000 (also applicable with DMV2000)
Camera	DMV-CD80GS
Lens	25mm focal length
Illumination	White coaxial light
Working distance	208 mm
FOV	40 mm x 30 mm

【 Inspecting Tool 】

Use the "Area" function to check whether the magnet is chipped, and then use the "Width Trace" function to check the gluing length

【 Key Point 】

The lighting should make the contrast of the gluing image prominent

【Result】

- The three gluing lengths (from top to bottom) are 374, 389, and 414
- If there is no glue on the magnet, the inspection result is 0. If the magnet has chips, more white zones will be revealed by the DMV system

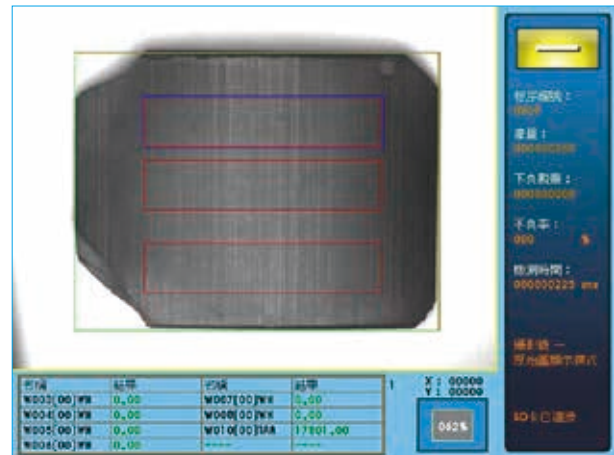

【Process】

Using the DMV Series to inspect the magnets helps remove the chipped ones and glue the intact ones. It can also check the glue length and removes the defective products to ensure smooth assembly

Advantages of the DMV system

This application fulfills the requirement for automatic inspection of the semi-product line

Electronics



Inspection Objectives

Inspection of SMT material direction

By using the DMV Series to inspect the direction of the material, the controller will trigger an output to alert operators when the material is reversed or upside down

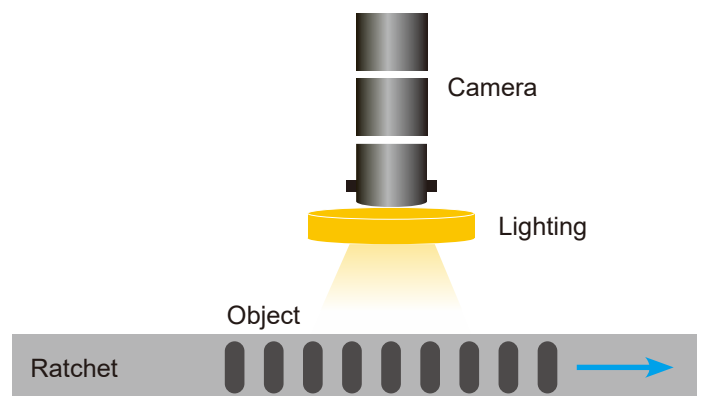
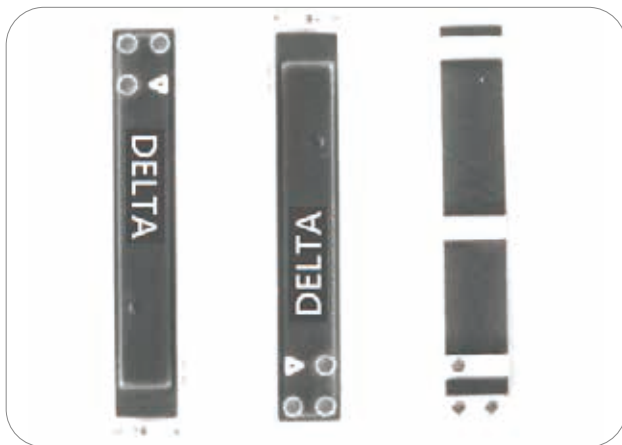

Device Configuration

Controller	DMV1000 (also applicable with DMV2000)
Camera	DMV-CD80GS
Lens	12 mm focal length
Illumination	75/46 low-angle ring light
Working distance	90 mm
FOV	40 mm x 30 mm

【 Inspecting Tool 】

Use the "Shape" function to locate the printed "DELTA" characters on the material

【 Key Point 】

Since the "DELTA" characters on the material are printed black on white with clear contrast, the "Shape" function is able to achieve stable and consistent results

【Result】

- Inspection speed: within 150ms
- The DMV Series identifies the material direction according to the matching rate of "DELTA" characters: up to 98% if the direction is correct/below 60% if opposite or back-sided

Correct direction **OK**



Opposite direction **NG**



Back side **NG**



【Process】

By using step motors to drive the ratchets of the SMT carrier, each material is sent one by one to pass under the camera. If an NG material is detected, the machine will stop and wait for manual removal

Advantages of the DMV system

The "Shape" function of the DMV Series allows consistent inspection results

Electronics

Inspection Objectives

Resistor laser engraving result detection

Check the laser engraving result on resistors, also ensure correct transfer direction

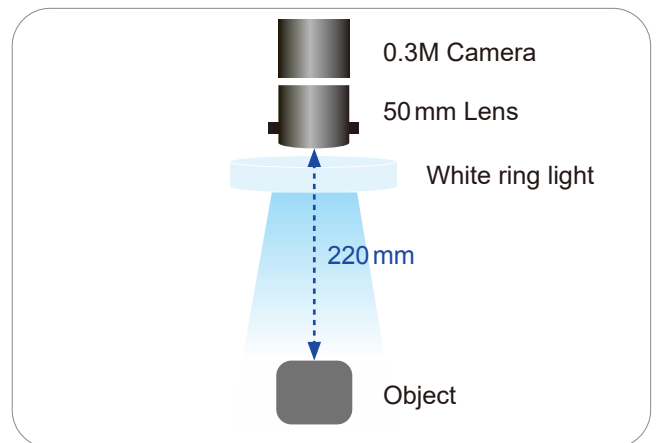
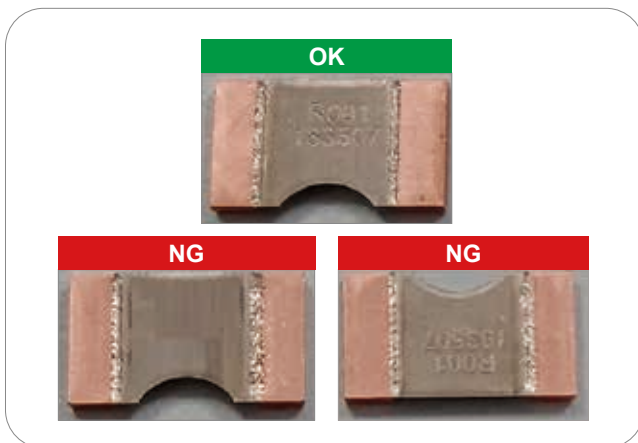

Device Configuration

Controller	DMV2000
Camera	DMV-CM30GCL
Lens	50 mm focal length
Illumination	White ring light
Working distance	220 mm
FOV	18 mm x 13.5 mm

【 Inspecting Tool 】

- Use "Shape" function to locate the resistor
- Use "Area" function to verify the laser engraving result

【 Key Point 】

Preset the angle limit for "Shape" function and area limit for "Area" function as the inspection criteria

【Result】

- The inspection time is about 45ms
- The inspection result is OK when the part is qualified (see the picture below)
- The inspection result is NG when there is no laser engraving on the resistor and determined as defective (see the picture below)

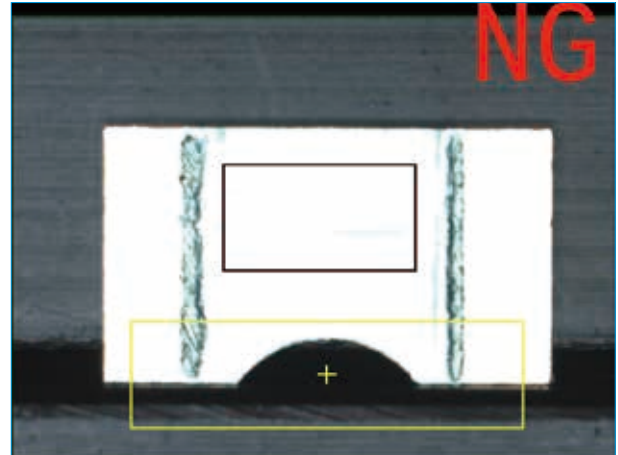
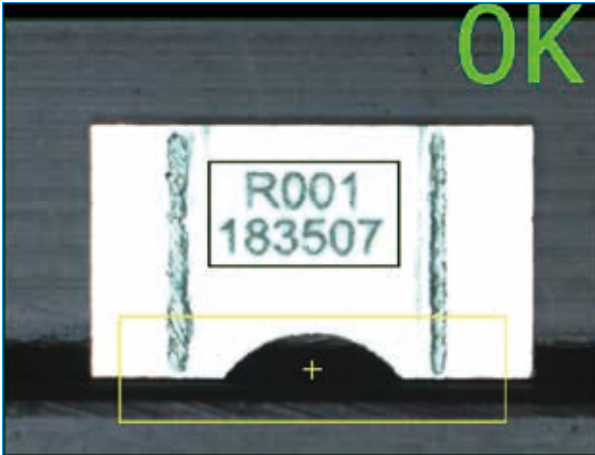

- The inspection result is NG when the transfer direction is incorrect (see the picture below)

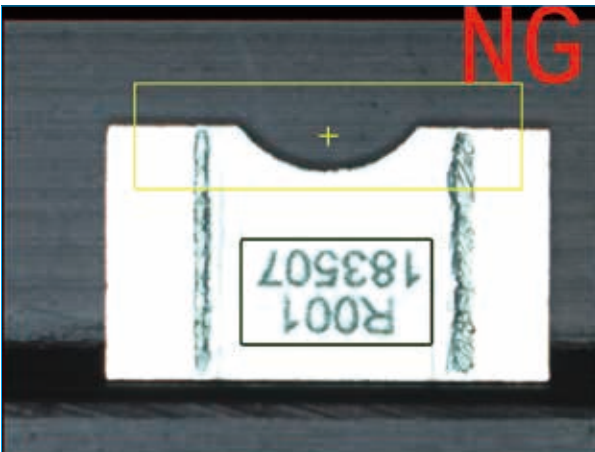

【Process】

Resistors under inspection pass under the camera, triggering the vision system to start inspection. Defective ones are excluded to ensure reliable product quality (the transfer speed is about 10pcs/sec.)

Advantages of the DMV system

Meets the requirement for quick material checking, suitable for welding, laser engraving and inspection processes

Electronics



Inspection Objectives

Coil angle checking

Check and correct the coil's outlet angle to weld properly

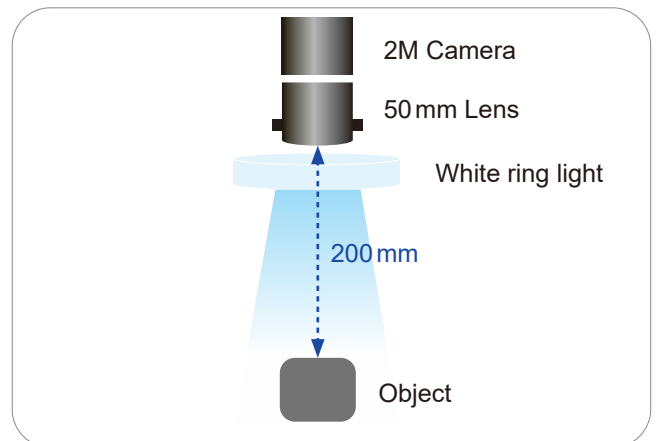
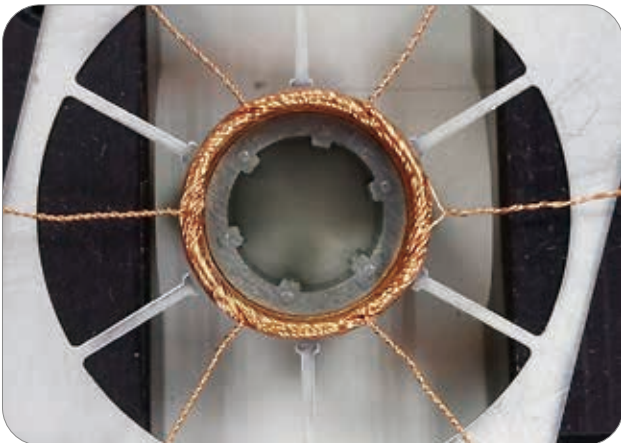

Device Configuration

Controller	DMV2000
Camera	DMV-CM2MCCL
Lens	50 mm focal length
Illumination	White ring light
Working distance	200 mm
FOV	45 mm x 22.5 mm

【 Inspecting Tool 】

- Use "Color Extraction" function to pick the coil's color
- Use "Edge Position" function to measure the coil's outlet angle

【 Key Point 】

Use "Color Extraction" function to pick the coil's color for a stable inspection image

【Result】

- The inspection time is about 200 ms
- Use "Color Extraction" function to pick the color. The images before and after the color is picked are as below

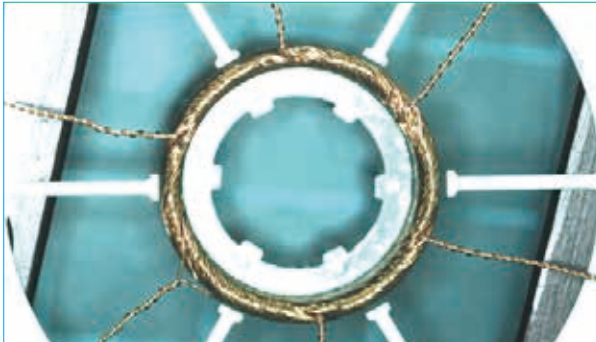

Before



After

- Use "Edge Position" function to measure each outlet angle (see the picture below)

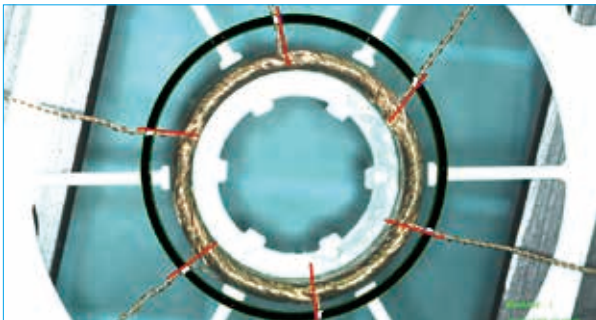

【Process】

The coil is transferred to the center of the silicon steel plate, triggering the vision system to measure 6 outlet angles. Then the plate rotates to weld each outlet

Advantages of the DMV system

Traditional process requires fixture to weld coil and silicon steel plate. Inspecting with the DMV system saves fixture maintenance cost and enhances product yield rate

Electronics

Inspection Objectives

Rotor alignment

Use 2 cameras to locate 2 notches at both sides of the silicon steel plate, calculate the rotor's angle deviation and make correction

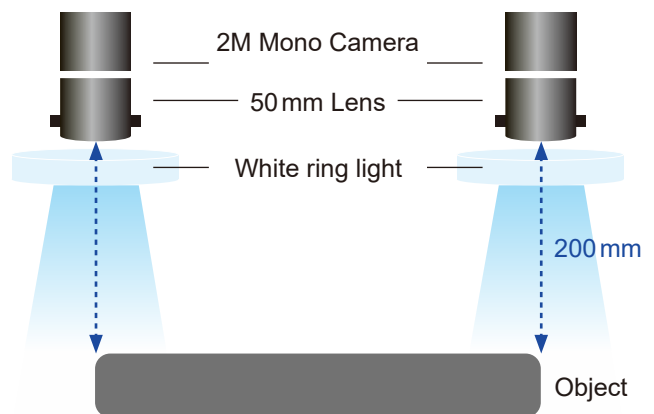

Device Configuration

Controller	DMV2000
Camera	DMV-CM2MGCLx2
Lens	50 mm x 2
Illumination	White ring light x 2
Working distance	200 mm
FOV	45 mm x 22.5 mm

【 Inspecting Tool 】

- Use "Shape" function to locate 2 notches
- Use "Position Trace" function to obtain the center coordinate of each notch
- Calculate the rotor's angle deviation by the 2 coordinates with "Panel_Angel Function"

【 Key Point 】

Several parameters are required for Panel Angle function, including the 2 cameras' mounting distance in X/ Y-axis. Therefore, it is necessary to make sure the parameters are correct before commissioning

【Result】

- The inspection time is about 200 ms
- This picture shows the inspection result when the angle deviation is 0 deg
- This picture shows the inspection result when there is a counterclockwise deviation (about 2.37 deg)

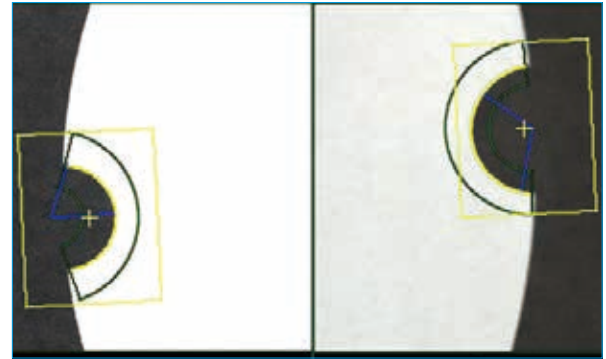
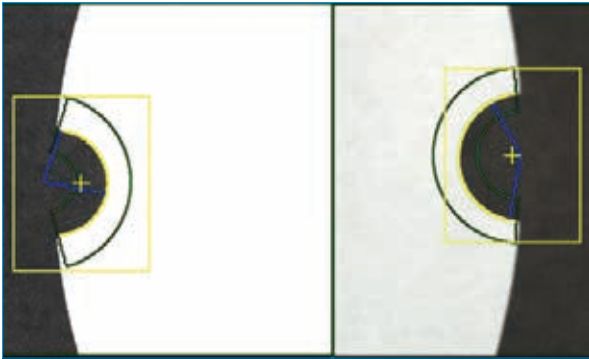

- This picture shows the inspection result when there is a clockwise deviation (about -3.49 deg)

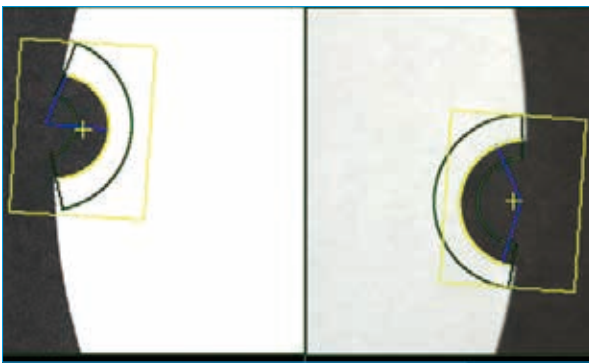

【Process】

The rotor is transferred to the inspection area for X/Y-axis location, triggering the vision system to detect the angle deviation, then the DD motor aligns the rotor for coil mounting

Advantages of the DMV system

Adopting the DMV system to calculate rotor angel deviation saves labor and fixture maintenance cost

Electronics

Inspection Objectives

Glass lens and zinc sheet alignment and adhesion

Inspect and locate the lens based on shape contour to ensure the correct picking point and precision of the following adhesion process

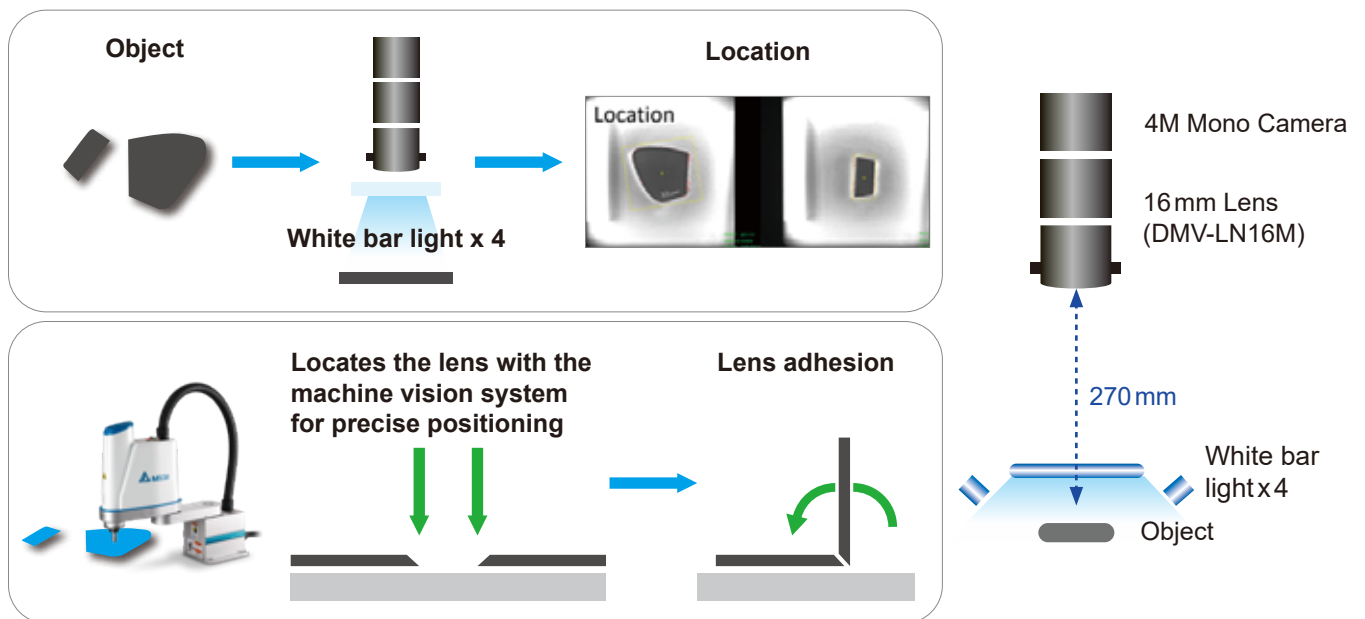

Device Configuration

Controller	DMV2000
Camera	DMV-CM4MGCL
Lens	16 mm focal length
Illumination	White bar light x 4
Working distance	270 mm
FOV	190 mm x 190 mm

【 Inspecting Tool 】

Use "Shape" function to determine the object's coordinate and angle, supporting four points learning (coordinate transformation) via a custom rotation center with the robot to ensure firm picking points

【 Key Point 】

A proper angle of light is necessary to avoid blurry edges due to light reflection, so that the robot can accurately locate the object on the conveyor

【Result】

- Capable of detection of the front/back of the object as well as exceptions, with a single inspection time within 300 ms and an optical accuracy up to 0.092 mm/pixel
- As each object is fed in from different positions, X, Y-axis coordinate and rotation angle of the two objects to be assembled are obtained via "Shape" function

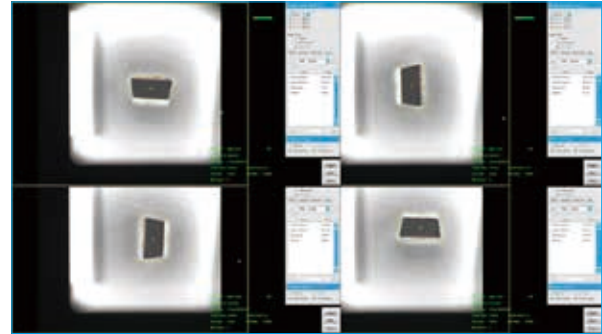
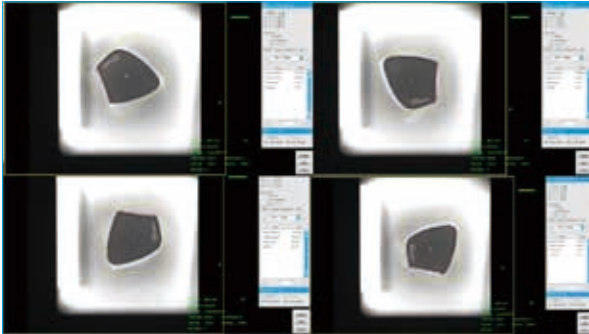

- "Shape" is not available when the object is placed bottom up

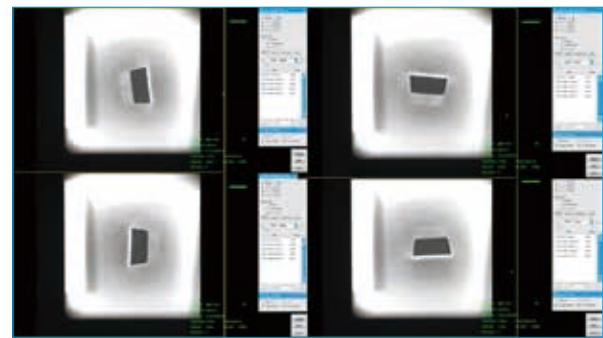
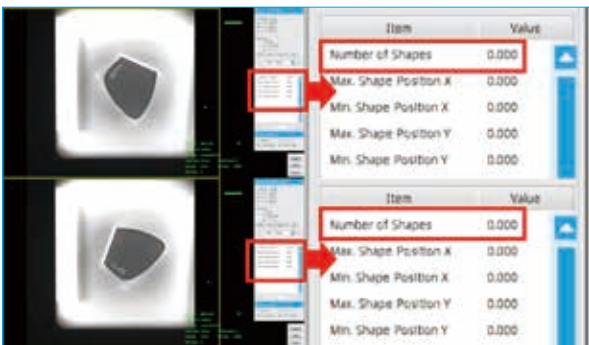

【Process】

Once the lens is fed in, the upper controller is triggered regularly to check the part status. The robot then puts the part to the fitting area for gluing and fits it by rotating. If there is a defective part, a NG signal is generated to request a pause, so that the defective part can be removed

Advantages of the DMV system

Traditional manual lens adhesion may lead to errors or inaccuracy due to long working hours and visual fatigue. Implementing the DMV not only solves the issue of manual errors, but also enhances adhesion accuracy to satisfy customers' demands

Semiconductor



Inspection Objectives

IC positioning Inspection

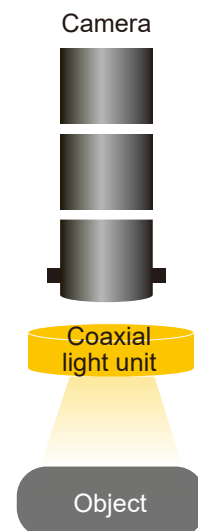
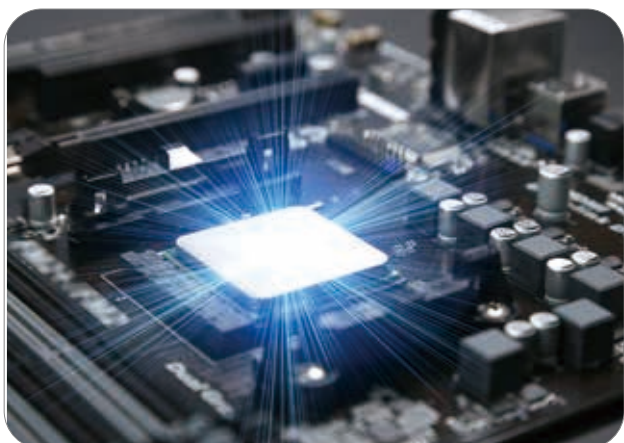

Device Configuration

Controller	DMV1000 (also applicable with DMV2000)
Camera	DMV-CD80GS
Lens	50 focal length
Illumination	Red coaxial light unit
Working distance	Approx. 210mm
FOV	Approx. 17mm x 12.8mm

【Inspecting Tool】

Use the "Shape" function to measure coordinates and shifting angles of IC chips

【Key Point】

Illumination strengthens the outline of the IC chip to enhance the positioning accuracy of the DMV system

【Result】

- Inspection speed: within 300 ms
- The DMV Series inspects the position of the IC chip sent to the inspection area and then identifies its coordinates

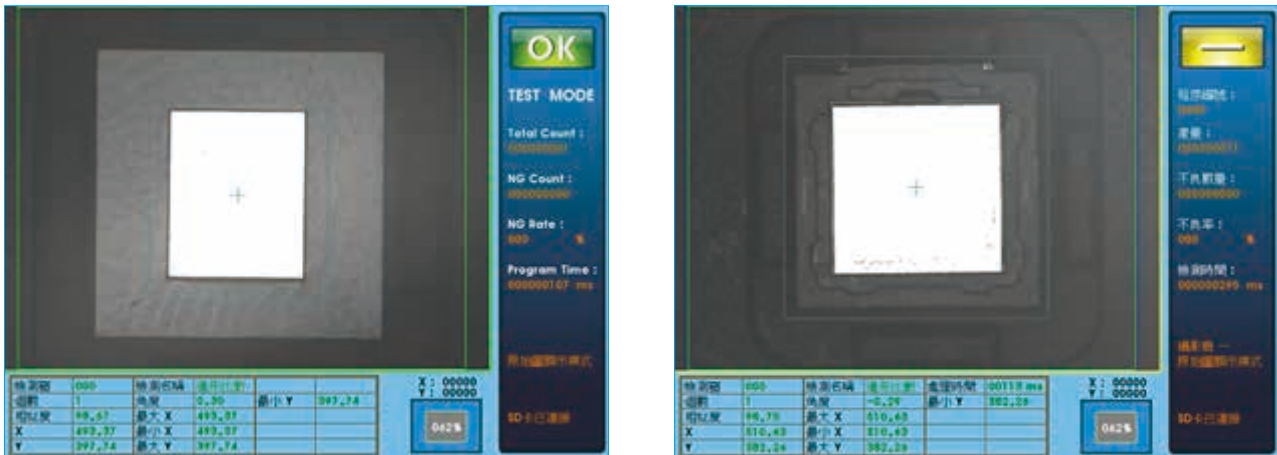

【Process】

- When an IC chip is sent to the inspection area, the PLC triggers the DMV Series to take a photo
- The PLC receives the inspection results every 200 ms via communication during DMV system operation, and controls the SCARA robots to pick and place the IC chips based on the results

Advantages of the DMV system

This system is customized to fulfill customers' requirements of labor cost reduction and production efficiency enhancement, as well as lowering the rate of manually damaged products

Semiconductors

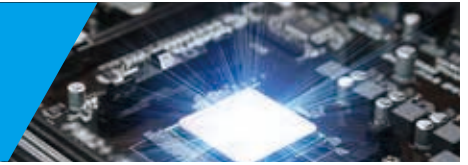

Inspection Objectives

Inspection of damaged solar panels

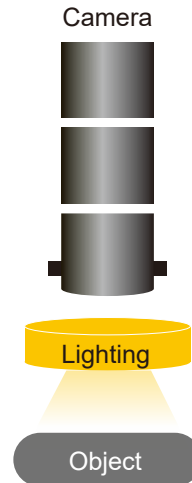

Device Configuration

Controller	DMV1000 (also applicable with DMV2000)
Camera	DMV-CD80GS
Lens	8mm focal length
Illumination	150mm red ring light at 60 degree + diffusion plate
Working distance	Approx. 400mm
FOV	Approx. 240 mm x 180 mm

【Inspecting Tool】

- Use the "Shape" function to position solar panels
- Based on the position result, use 8 "Position Trace" functions to identify whether the edge of the solar panel is damaged

【Key Point】

The "Position Trace" function offers 2 defect inspections: "Depth of Damage" and "Area"

Shallow depth / wide area: "Area" inspection

Deep depth / small area: "Depth of Damage" inspection

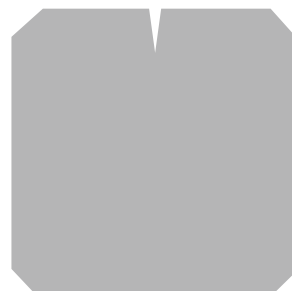

【Result】

- Inspection speed: within 800 ms
- The system stably inspects damaged spots of approx. 1 mm (customer's requirement: damage inspection within the range of 2 mm)

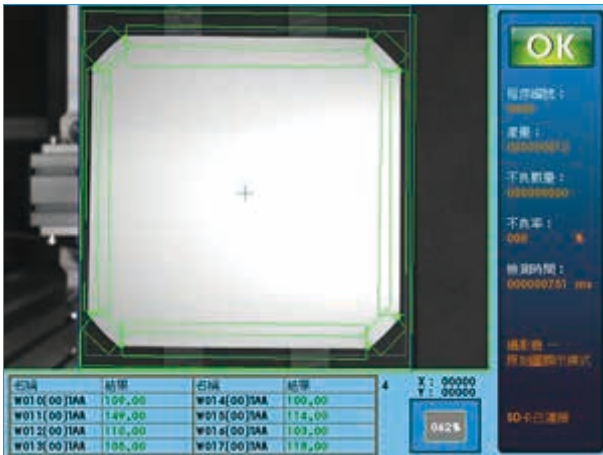

【Process】

- Solar panels are sent to the inspection area (under the camera)
- The master controller triggers the camera to take a photo. The DMV Series inspects the image in the photograph and identifies if the solar panel is damaged by showing OK/NG within 800 ms. If the result shows NG, the defective panel will be removed in the next process

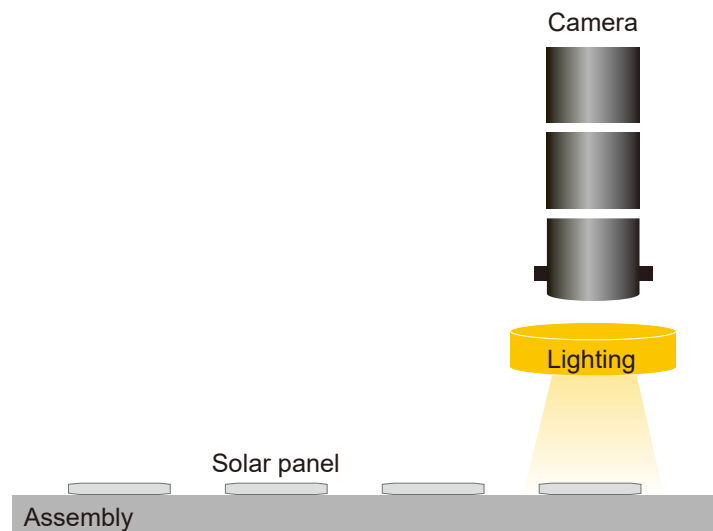

Advantages of the DMV system

Damaged solar panels are easily missed by human visual inspection. With the "Position Trace" of the DMV Series, damaged solar panels can be stably and correctly detected and removed to enhance production efficiency and yield rate

Semiconductors



Inspection Objectives

Cell phone glass panel positioning

With the DMV Series positioning cell phone panel glass (within 1 mm accuracy), the SCARA robot picks up the object

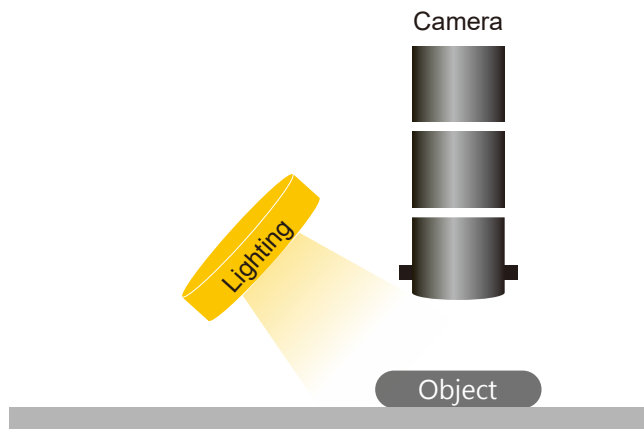

Device Configuration

Controller	DMV1000 (also applicable with DMV2000)
Camera	DMV-CD80GS
Lens	8mm focal length
Illumination	Side Bar light
Working distance	670 mm
FOV	400 mm x 300 mm

【 Inspecting Tool 】

Use the "Shape" function to position cell phone panel glass

【 Key Point 】

- When matched with the SCARA robot, the "4-point learning" function is enacted to transform the visual coordinates to the SCARA robot coordinates
- Even illumination is necessary for the best inspection result

【Result】

- Inspection speed: within 700 ms
- The positioning accuracy can be controlled within 1 mm with even illumination from 4 directions

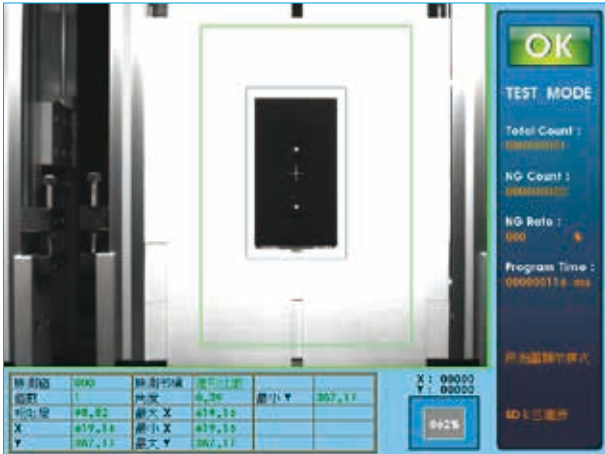

【Process】

When the panel glass is delivered to the inspection area, the DMV Series is triggered to take photos, and transforms the visual coordinates to the SCARA coordinates. The SCARA robot picks up the object based on the SCARA coordinates

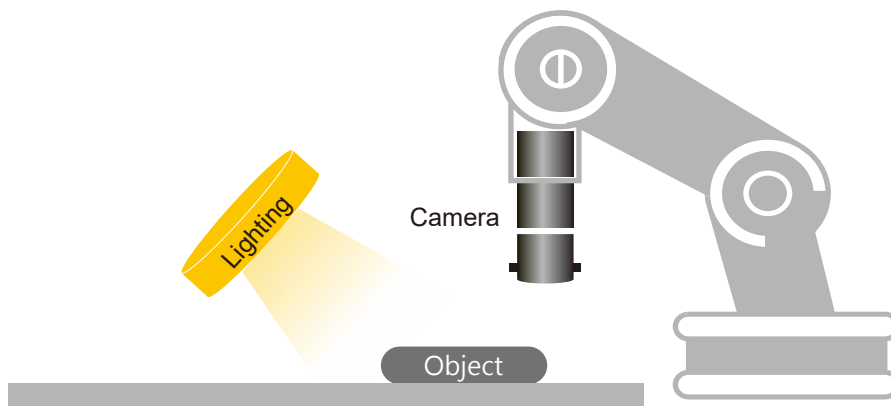

Advantages of the DMV system

Integrates SCARA robot and the DMV system to achieve unmanned automation

Semiconductors



Inspection Objectives

OCV inspection for laser engraving on semiconductors

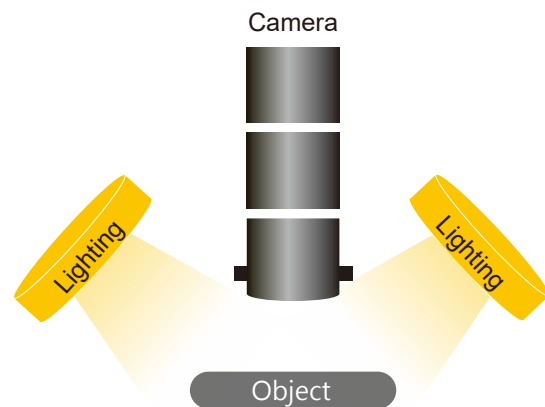

Device Configuration

Controller	DMV1000 (also applicable with DMV2000)
Camera	DMV-CD80GS
Lens	25mm focal length
Illumination	100mm white bar light + diffusion plate x 2
Working distance	Approx. 300mm
FOV	Approx. 60mm x 45mm

【Inspecting Tool】

- Use the "Shape" function to position the wafer holder
- Based on the position result, use the "OCV" function to detect characters

【Key Point】

- The laser engraved characters can be clearly shown with lighting that provides the most contrast
- After setting up the environment for image capture, add the characters into the database, and then use the "OCV" function in the DMV Series for character detection

【Result】

- Inspection speed: within 800 ms
- The DMV Series can detect up to 2 lines of characters (22 characters each line)



【Process】

- The SCARA robot takes the object to the inspection area
- After the camera captures images, the computer reads the character detection result via the RS-232 communication interface

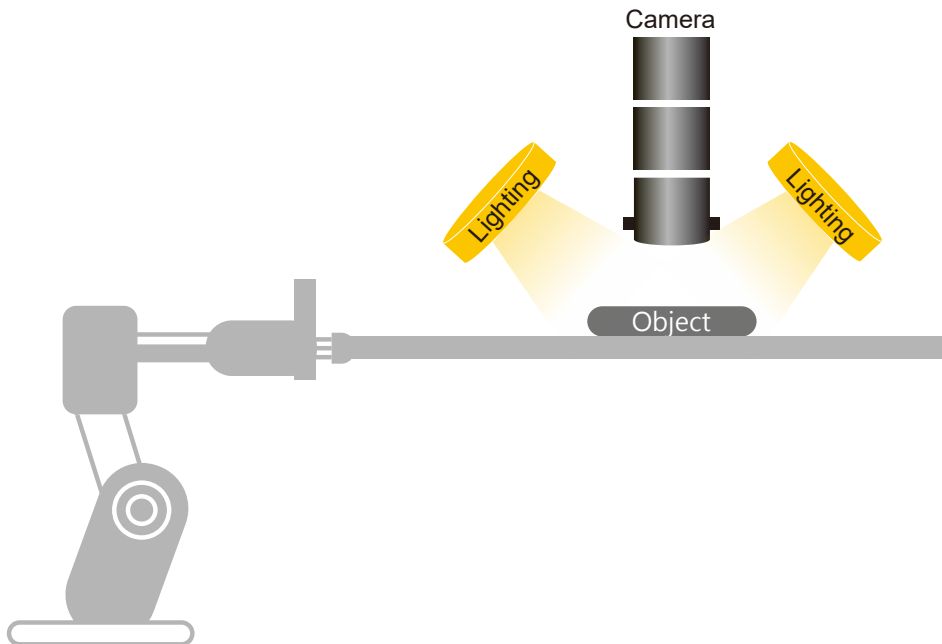

Advantages of the DMV system

The DMV Series stably detects up to 2 lines of characters (with 22 characters each line) for production status monitoring

Machine Tools



Inspection Objectives

Ball dimple space measurement

3 patterns are provided for golf ball dimple space measurement: Normal, Large and Small

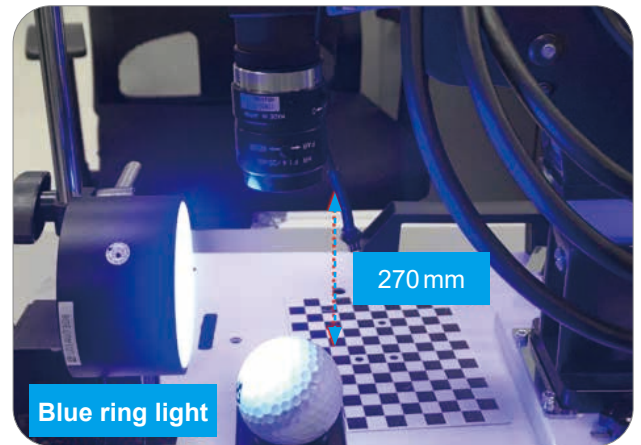

Device Configuration

Controller	DMV1000 (DMV2000 also applies)
Camera	DMV-CD80GS
Lens	25 mm focal length + 5 mm extension ring
Illumination	Blue ring light (with diffusion panel)
Working distance	70 mm
FOV	14.6 mm x 11 mm
Extension ring	5 mm

【 Inspecting Tool 】

- Use "Shape" function to locate the ball
- Use "Edge Position" function to find the upper and lower edges of dimple

【 Key Point 】

The ball is inspected under high speed revolving (1350 rpm), therefore the shutter time must be short enough to avoid blurry images

【Result】

Take 432 type golf ball as an example, the lower edge of the upper dimple and the upper edge of the lower dimple are measured, then the space is calculated as below:

- The optical accuracy is about 0.0143 mm/pixel, with a single inspection time within 200 ms
- Normal space: about 0.554 mm (38.72 pixel x 0.0143 mm/pixel)

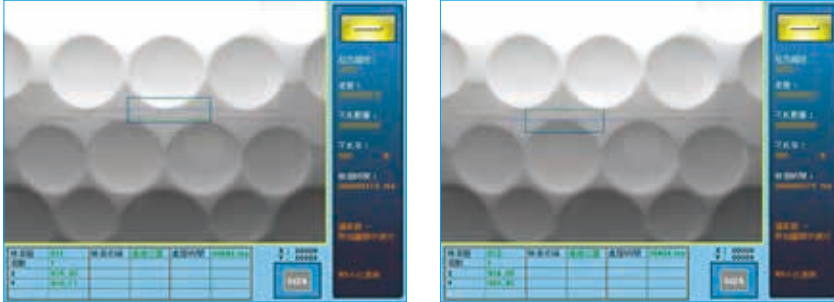

- Large space: about 0.916 mm (64.08 pixel x 0.0143 mm/pixel)

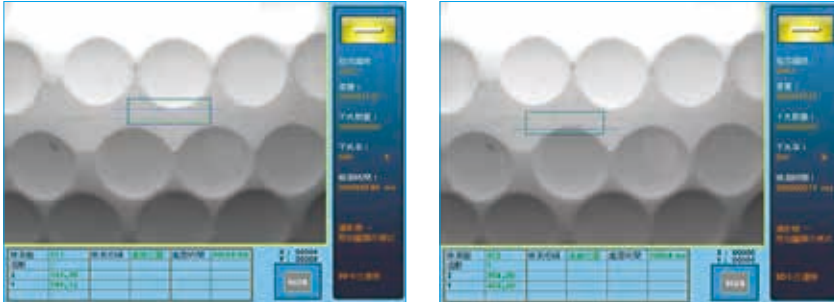

- Small space: about 0.248 mm (17.36 pixel x 0.0143 mm/pixel)

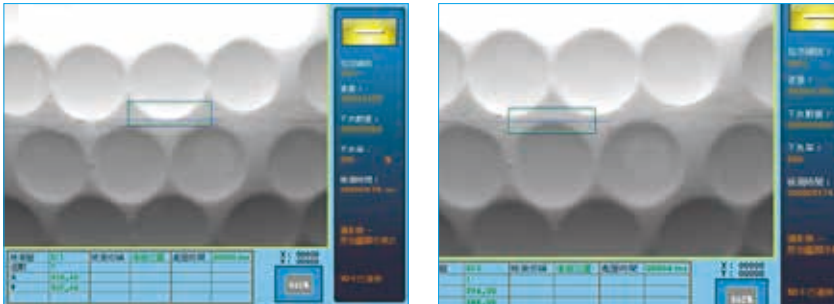

【Process】

The golf ball is continuously revolving during conveying. Once it reaches the inspection area (edging machine), the dimple space is measured, then compared with the preset upper/lower limit to determine the inspection result

Advantages of the DMV system

Traditional manual ball spot-check is inconsistent and time-consuming. With DMV system implemented, finished products can be 100% auto-inspected, saving time and labor while ensuring quality

Machine Tools



Inspection Objectives

Chamfering/radius R measurement

Measure the chamfers and radius R of screws if in the qualified range

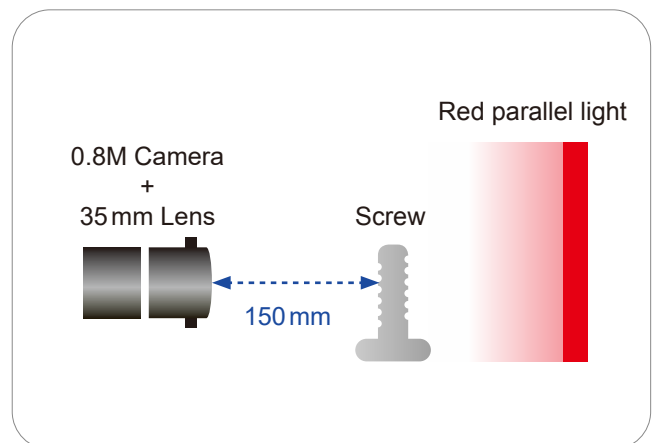

Device Configuration

Controller	DMV1000 (also applicable with DMV2000)
Camera	DMV-CD80GS
Lens	35 mm focal length
Illumination	Red parallel light
Working distance	150 mm
FOV	20 mm x 15 mm

【 Inspecting Tool 】

- Use "Shape" function for initial location of screws
- Use "Edge Angle" function to check the screw for chamfering
- Measure 3 coordinates on the semicircle with "Edge Position" function. DMV will calculate radius R

【 Key Point 】

Parallel light is recommended due to the high precision measurement requirement for halo-free, and can also be used with parallel light lens

【Result】

Chamfering measurement:

- Use "Shape" function for initial location when feeding (see the cross in the figure below)
- Based on the result, use "Edge Angle" function to measure the edge angle on both sides
- The left angle is measured to be 134.70, and the right is 44.03 (see the picture below)
- The measurement result can be used to determine whether the chamfering exists. For example, when the left angle is measured to be less than 100.00, it can be determined as no chamfering and the result is NG

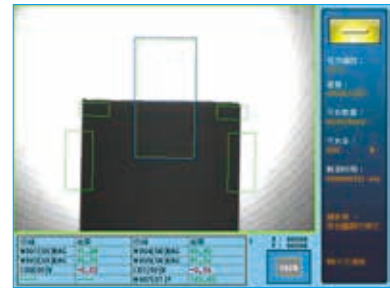
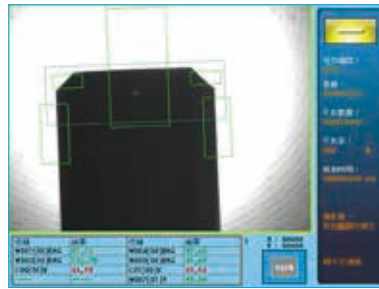
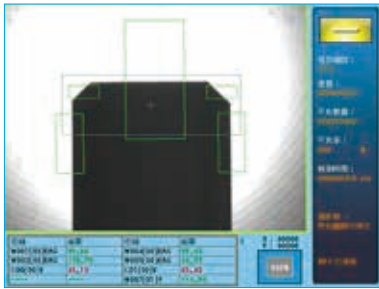

With the initial location, the chamfering can be measured properly even when the part is rotating

No chamfering. The left angle is measured to be 90.76 (<100), thus it is determined as defective

Radius R measurement:

- Use "Edge Position" function to obtain 3 coordinates from top to bottom, then calculate radius R with the calculator of DMV. The radius R is 19.15 in the picture below



CIRCLE_X	X coordinates of circle formed by three points	CIRCLE_X (X1,Y1,X2,Y2,X3,Y3) CIRCLE_X (-14.6,8.94,-11.64,4.15,-15.61,3.47) = -14	
CIRCLE_Y	Y coordinates of circle formed by three points	CIRCLE_Y (X1,Y1,Y2,X3,Y3) CIRCLE_Y (-14.6,8.94,-11.64,4.15,-15.61,3.47) = 8	
CIRCLE_R	Radius (R) of circle formed by three points	CIRCLE_R (X1,Y1,X2,Y2,X3,Y3) CIRCLE_R (-14.6,8.94,-11.64,4.15,-15.61,3.47) = 19.15	

【Process】

Screws pass through the sensor, triggering the DMV system to start taking pictures and inspection. When the result is NG, the system drives the cylinder to recover the defective part to enhance the yield rate

Advantages of the DMV system

It is difficult to manually inspect finished products during the screw turning process. With the DMV system implemented, it can inspect and discard defective products, and transmit the continued defective status info to the host controller due to equipment damage. It controls the product quality, and prevents defective products from entering the market

Machine Tools



Inspection Objectives

Bottle cap, label and water level inspection

Check bottle caps, bottle labels and water level. Generate a NG signal in case of any exceptions

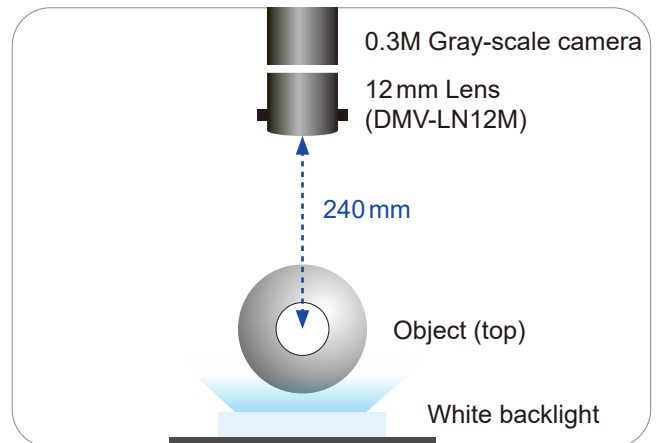

Device Configuration

Controller	DMV2000
Camera	DMV-CM30GCL
Lens	12 mm focal length
Illumination	White backlight
Working distance	240 mm
FOV	96 mm x 72 mm

【 Inspecting Tool 】

- Use "Edge Position" function to locate bottles
- Use "Area" function to verify if the bottle has a cap and a label
- Use "Edge Position" function to check the water level

【 Key Point 】

Ensure the sensor trigger time error is not too high during feeding

【Result】

- During production, bottles are fed into the inspection area in a horizontal direction. The sensor triggers the machine vision system to take pictures and locate bottles via "Edge Position" function
- Use "Area" function to check caps. As shown in the picture below, if the bottle has a cap, the black area should be greater than 2000

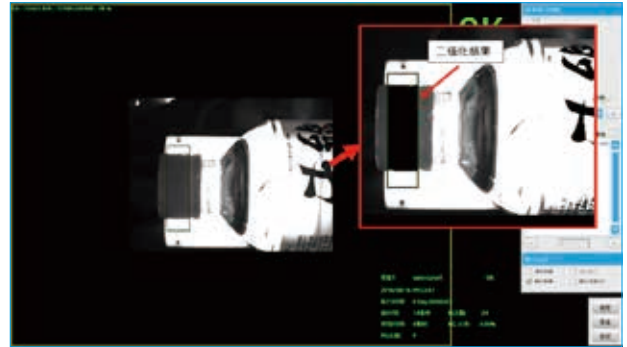
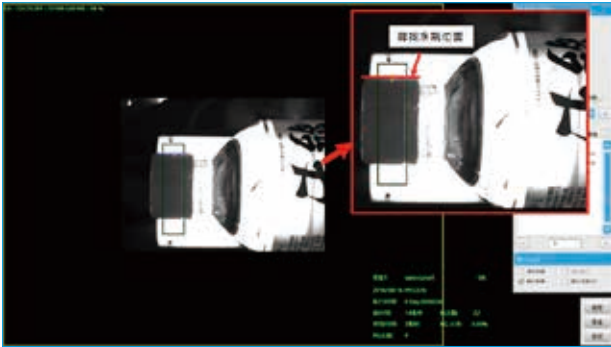

- Also use "Area" function to check labels. As shown in the picture below, if the bottle has a label, the area of printed content should be greater than 1500
- Use "Edge Position" function to check the water level. The picture below shows "Edge Position Tool" that properly locates the water level

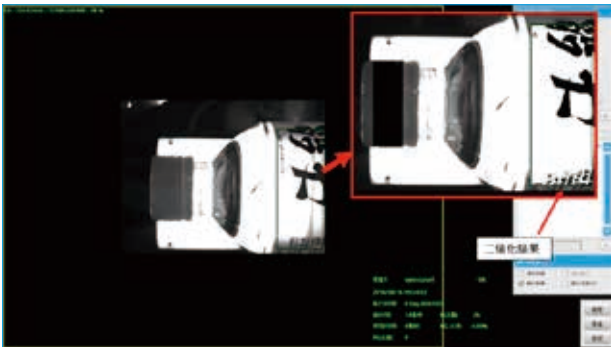

【Process】

Once the bottle enters the inspection area and triggers the sensor, the PLC will inform DMV to start inspection, with defective products rejected

Advantages of the DMV system

Prevents defective products from entering the market and fulfills customer requirements for auto detection

Machine Tools



Inspection Objectives

OCV inspection of keys

Check the text on keys, and generate an NG signal in case it is incorrect

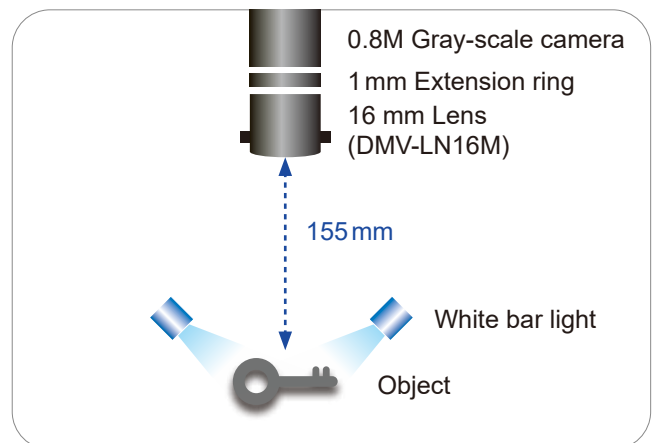

Device Configuration

Controller	DMV1000 (also applicable with DMV2000)
Camera	DMV-CD80GS
Lens	16 mm focal length + 1 mm extension ring
Illumination	White bar light
Working distance	155 mm
FOV	46.5 mm x 34.9 mm

【Inspecting Tool】

- Use "Shape" function to locate keys
- Use "OCV" function to verify if the text on keys is correct

【Key Point】

Make sure the illumination is stable and the text on keys is clear enough

【Result】

- Use "Shape" function to locate the key, which may be fed in with some offset
- Use "OCV" function to read and verify the text



- "OCV" function can still read the text properly even if the keys are placed in different directions



- In case of any deformation or out of range due to text deflection, unstable inspection result or even recognition failure will result (see the picture below)



【Process】

Once the key enters the inspection area and triggers the sensor, the PLC will inform DMV to start text inspection, with defective products rejected

Advantages of the DMV system

Traditional manual OCV inspection of keys may lead to errors or inaccuracy due to long working hours and visual fatigue. With the DMV system implemented, it not only solves the issue of manual errors, but also enhances accuracy to satisfy the customer's demands

Machine Tools



Inspection Objectives

SMT socket blockage inspection



Device Configuration

Controller	DMV1000 (also applicable with DMV2000)
Camera	DMV-CD80GS
Lens	110mm, 2 x parallel optical lens
Illumination	4218 white top ring light
Working distance	110 mm
FOV	2.4 mm x 1.8 mm

【Inspecting Tool】

- Use "Area" function
- The blockage spot is shown as a white area, by which the DMV Series can determine whether the socket is blocked by calculating the white area

【Result】

- Inspection speed: within 200 ms
- Stably inspected when over 1/5 of the socket diameter is blocked

【Key Point】

Illumination angle is crucial. When lighting is set at the correct position, the blob of the blockage spots will be clearly shown in the white image

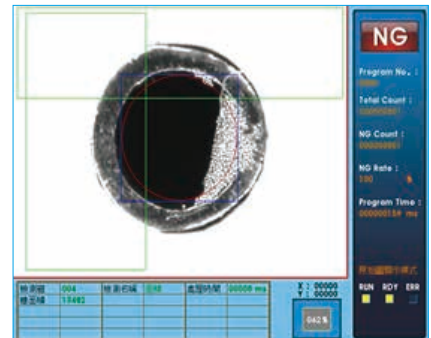

【Process】

- Camera and illumination are above the object; direct lighting is used for image captures
- The installation hole of each type of socket is identical in size. Create a standard hole on the workstation, and then manually place the sockets onto it for inspection

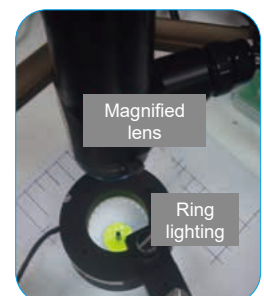

Advantages of the DMV system

Because the size of the socket is small and difficult to inspect, a magnification lens and strengthening light are needed for stable inspection

Machine Tools



Inspection Objectives

Finished workpiece inspection

Confirming presence of tap in workpiece with the DMV system

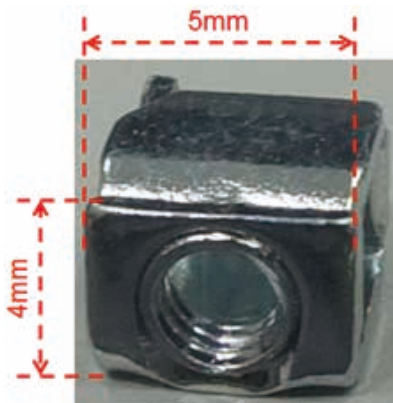

Device Configuration

Controller	DMV1000 (also applicable with DMV2000)
Camera	DMV-CD80GS
Lens	Lens 160mm focal length + 8mm extension ring
Illumination	Red ring light
Working distance	19 mm
FOV	10 mm x 7 mm

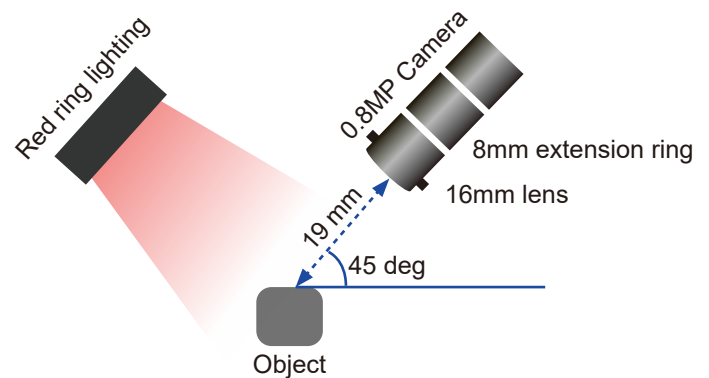

【Inspecting Tool】

Use "Edge Count" function

【Key Point】

The lens must be installed at a tilt to inspect the presence of taps, and illumination is needed to create enough contrast over the screw threads

【Result】

The DMV system detects certain amounts of edge quantity to confirm the presence of taps

【Process】

Inspection starts after placing the workpiece onto the workstation



Advantages of the DMV system

Fulfills the requirement for real-time auto inspection right after assembly

Machine Tools



Inspection Objectives

Inspection of workpiece in the terminal blocks

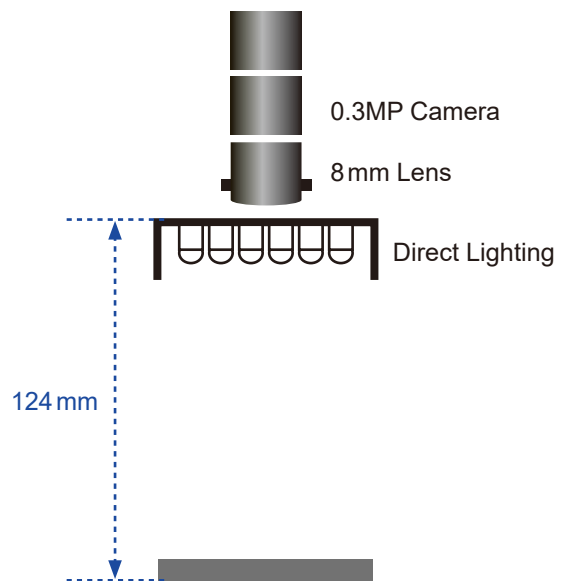
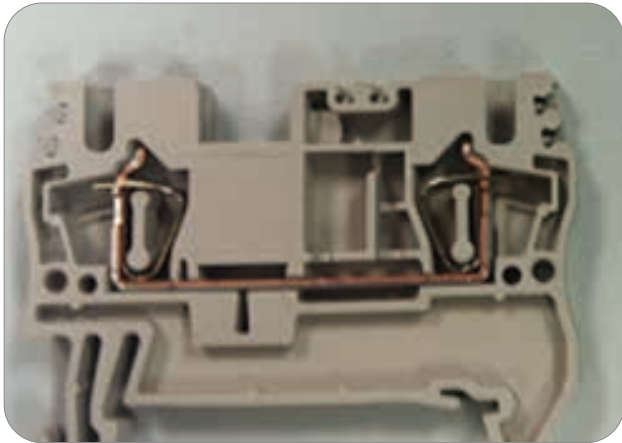

Device Configuration

Controller	DMV1000 (also applicable with DMV2000)
Camera	DMV-CD30GS
Lens	8mm focal length
Illumination	Direct Lighting
Working distance	124 mm
FOV	49 mm x 35 mm

【Inspecting Tool】

- Use the "Shape" function to initially position terminal blocks
- Use multiple "Area" functions to confirm whether the workpiece is found

【Key Point】

Direct vertical illumination must be used to achieve maximum reflectivity of the workpiece

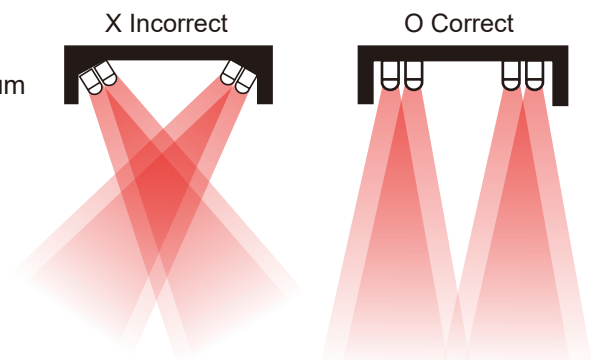

【Result】

- Use 3 "Area" functions to detect a certain amount of white blob when the workpiece is present
- If the workpiece is not assembled, those 3 "Area" functions can only detect a smaller area of white blob

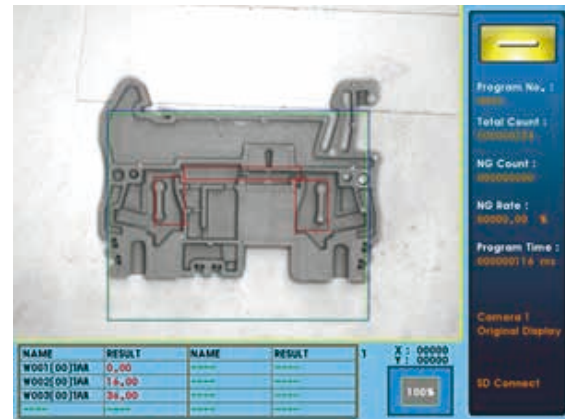
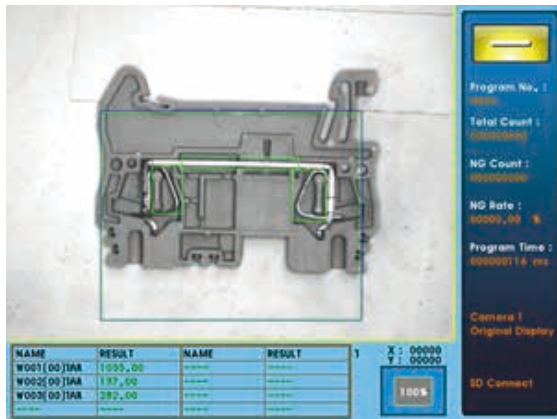

【Process】

The finished terminal blocks will be delivered via conveyors to the area for machine vision inspection. Terminal blocks with the target workpiece found will continue, whereas the ones without the target workpiece found will be discarded

Advantages of the DMV system

Fulfills the requirement for real-time auto inspection right after terminal blocks are assembled at the production line

Machine Tools



Inspection Objectives

Metal workpiece quality inspection

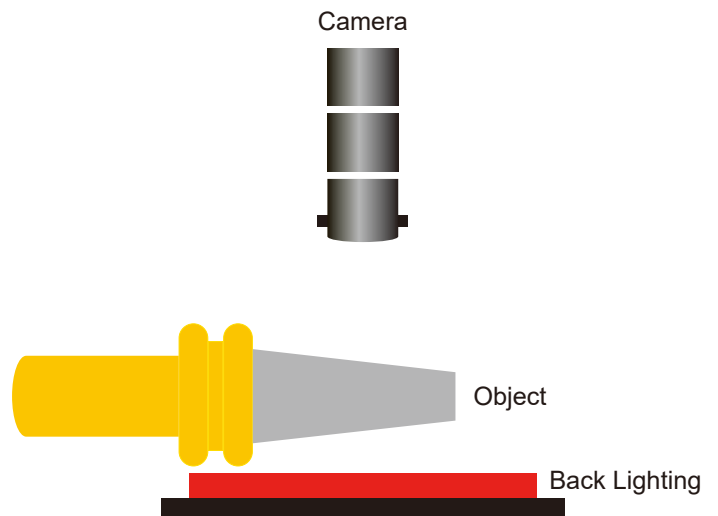

Device Configuration

Controller	DMV1000 (also applicable with DMV2000)
Camera	DMV-CD80GS
Lens	8 focal length
Illumination	Red back lighting
Working distance	Approx. 158 mm
FOV	Approx. 100 mm x 75 mm

【Inspecting Tool】

- Use the "Edge Position" function to position the metal workpiece in the screen
- Use the "Position Trace" function at the positioning area to measure the length of the metal workpiece's cone section

【Key Point】

The angle of camera set up is crucial since a tilted camera may cause size inspection inaccuracies

【Result】

- Inspection speed: within 200 ms
- When the SCARA robot sends a metal workpiece to the inspection area, the DMV system inspects from the side to measure if the distance from the tip to the bottom of the metal workpiece is within the standard range
- Use the "Edge Position" function to get the Y coordinate of the workpiece by scanning vertically, and then get the X coordinate by scanning horizontally

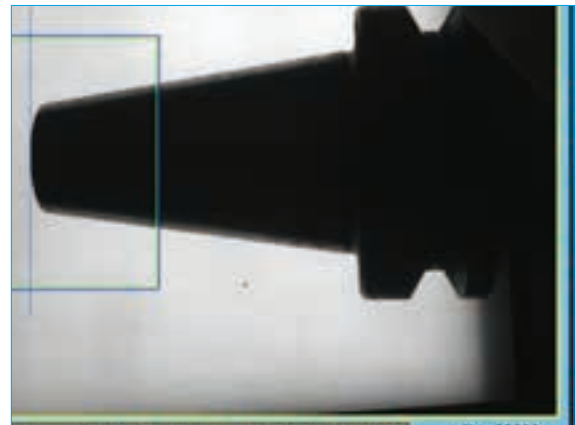

- Use the "Position Trace" function to get the coordinates of the tip and bottom of the cone for distance calculation



【Process】

- When a workpiece is sent to the inspection area, a PLC triggers the DMV Series to take photos
- The PLC receives the inspection results every 200 ms via communication during the DMV system operation, and continues the process or discards the defects based on the results

Advantages of the DMV system

This solution fulfills the customer's requirement of using the DMV Series to assist in standardizing the distance from the tip to the bottom of the workpiece, reducing defective products

Automotive



Inspection Objectives

Inspection of automobile A/C buttons

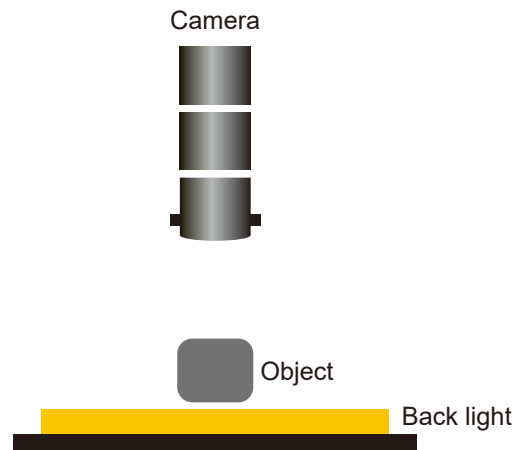

Device Configuration

Controller	DMV1000 (also applicable with DMV2000)
Camera	DMV-CD80GS
Lens	25 focal length + 2 mm extension ring
Illumination	Red back light
Working distance	Approx. 168 mm
FOV	Approx. 32.5 mm x 24.4 mm

【 Inspecting Tool 】

- Use the "Shape" function to position the image in the button
- Use the "Area" and the "Intensity" functions to calculate the enlightened area of the man icon and the downward arrow

【 Key Point 】

Cameras must be triggered only when the object completely enters the inspection area in order to avoid misjudgment

【Result】

- Inspection speed: within 200 ms
- When an automobile air conditioner button enters the inspection area, the DMV Series captures its images; use the "Shape" function to acquire its X, Y coordinates and rotation angle, and then use the "Area" function to examine if it contains any extra enlightened area
- When a defect is inspected, the system will send a NG signal to the controller



- The "Area" function inspects an extra enlightened area of 664 pixels (an extra arrow) which exceeds the standard range and is recognized as a defect



【Process】

- When the object enters the inspection area, the controller will trigger an output to take photos and complete the inspection within 200 ms
- Then the defects will be picked out based on the result sent by the controller

Advantages of the DMV system

The DMV integration enhances production efficiency and reduces the defect rate

Automotive



Inspection Objectives

Inspection of laser scribed electrical resistance in automobiles

Detects the position of 3 electrical resistors with the DMV Series for precise laser scribing

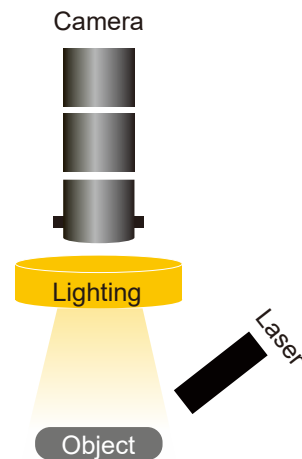
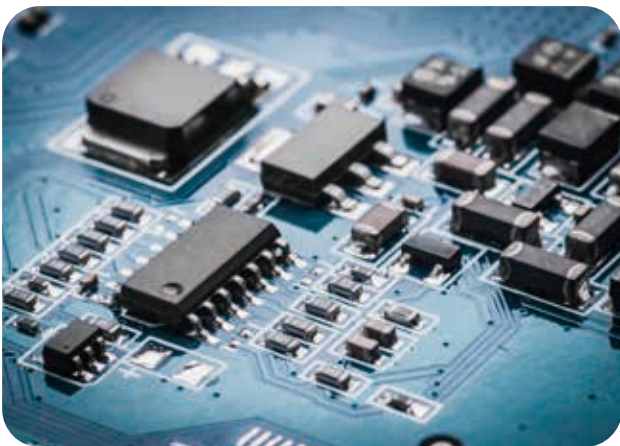

Device Configuration

Controller	DMV1000 (also applicable with DMV2000)
Camera	DMV-CD80GS
Lens	12mm focal length
Illumination	6736 white ring light
Working distance	160 mm
FOV	100 mm x 75 mm

【 Inspecting Tool 】

Use the "Shape" function to position, and then use 3 "Blob" functions to find the location of black electric resistors

【 Key Point 】

Use the "Shape" function to position the default coordinates in order to precisely perform laser scribing

【Result】

- Inspection speed: within 500 ms
- Positioning accuracy maintains within 0.5 mm to meet customer requirements



【Process】

- After manually placing the object, the DMV Series acquires their X-Y coordinates for the controller to perform precise laser scribing

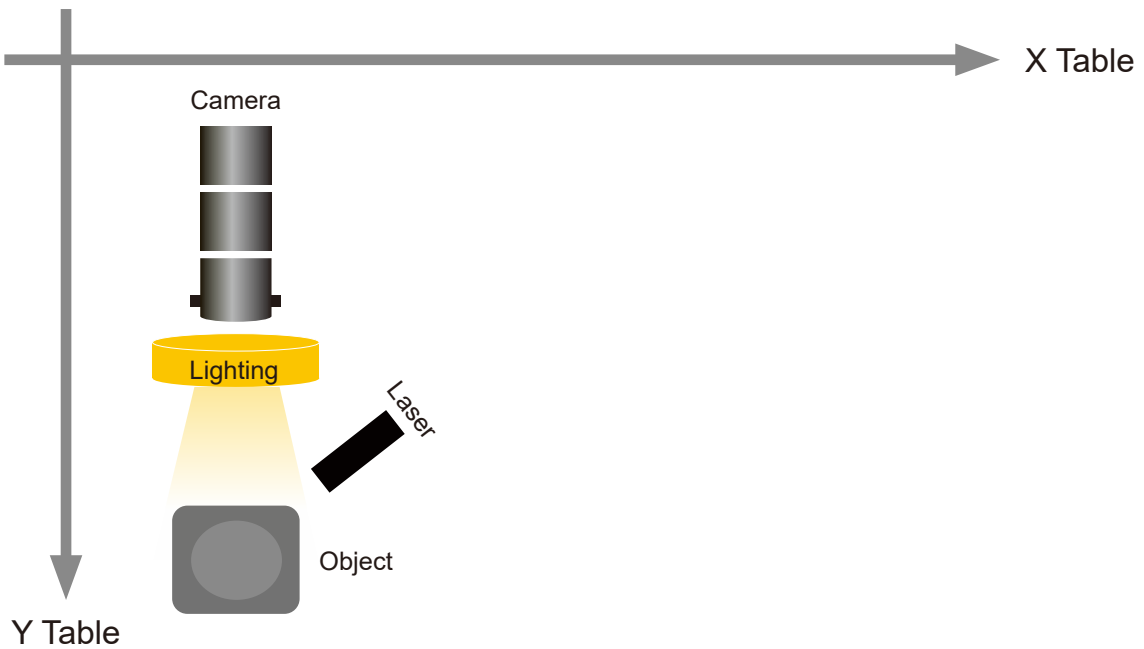

Advantages of the DMV system

Offsets and unstable quality are often found in a manual laser scribing process. The use of DMV Series helps to enhance production speed and precision, and ensure constant product quality

Automotive



Inspection Objectives

Chromed trim inspection

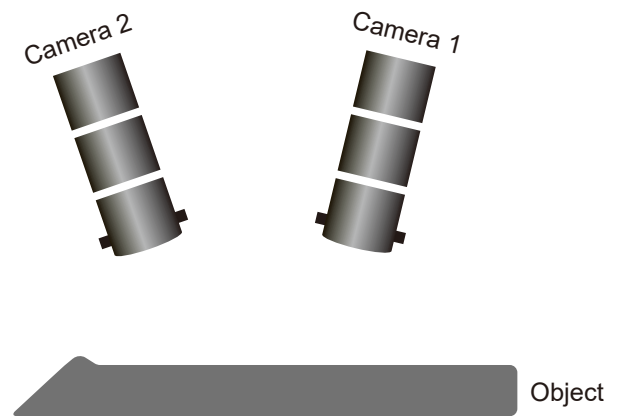

Device Configuration

Controller	DMV1000 (also applicable with DMV2000)
Camera	DMV-CD80GS
Lens	8 mm focal length x 2
Illumination	Ambient light
Working distance	600 mm for camera 1 and 2
FOV	370 mm x 277 mm

【 Inspecting Tool 】

- Use 2 "Shape" functions to position the chromed trim
- Use 6 "Area" functions to inspect whether the washers are correctly installed on it

【 Key Point 】

- The installation height of the two cameras is crucial for capturing images of each half of the washers on the chromed trim
- As the car chromed trim reflects easily, avoid reflection when casting light

【Result】

- Inspection speed: within 500ms
- The number of the washers in car chromed trim can be correctly inspected (black washers installed above white washers)
- Black washer installation inspection: use the "Area" function to inspect washer installation spots. As in the images shown below: when a black washer is correctly installed, the black area value is 1,181 pixels; when there is no black washer and a white washer beneath it is exposed, the black area value is only 241 pixels, which is below the normal value



- White washer installation inspection: use the "Area" function to inspect washer installation spots. As in the images shown below: when a white washer is correctly installed, the white area value is 1030 pixels; when the white washer is removed, the white area value diminishes to 252 pixels



【Process】

- When the worker completes assembly, the DMV Series starts to take photos
- The DMV Series sends the OK/NG signals to the controller via I/O communication. If the result shows NG, the controller will trigger an output to alert operators

Advantages of the DMV system

The DMV system effectively helps the automobile component manufacturer to identify accurate installation of washers on the chromed trims, greatly reducing the defect rate

Automotive



Inspection Objectives

Exhaust pipe inspection

Use the DMV Series to inspect the digits on the pipe side and the fiber glass pack placed in the pipe

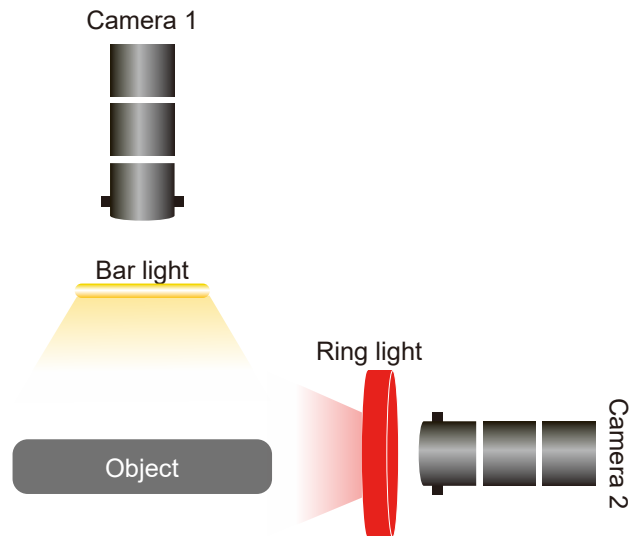

Device Configuration

Controller	DMV1000 (also applicable with DMV2000)		
Camera 1	DMV-CD80GS	Camera 2	DMV-CD80GS
Lens	12mm focal length	Lens	8mm focal length
Illumination	LED bar light *2	Illumination	Red ring light
Working distance	763 mm	Working distance	333 mm
FOV	300mm x 225 mm	FOV	200mm x 150 mm

【 Inspecting Tool 】

- 2 Cameras are used for this application. Camera 1 uses the "Shape" function to position the pipe, and then uses the "Area" function to confirm whether the pipe contains a fiber glass pack inside
- Camera 2 uses the "Shape" function to position the digits on the side of the pipe, and then uses 2 "Shape" functions to confirm whether the numbers steel printed on the pipe side are correct
- Use the "Blob" function to recognize dual-pipe or triple-pipe

【 Key Point 】

- The lighting needs to contrast the characters on the workpiece surface
- Positioning functions are suggested to apply to prevent offset

【Result】

1. Camera 1 uses the "Shape" function to position



2. Use the "Area" function to inspect the placement of the fiber glass pack

(When the fiber glass pack is placed, the total white area value is 14,167 pixels)



3. Camera 2 uses the "Shape" function to position

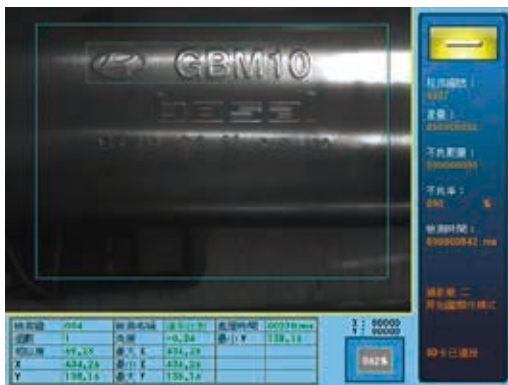

4. Confirm the characters with the "Shape" function



5. Use the "Shape" function to examine whether the steel print is present

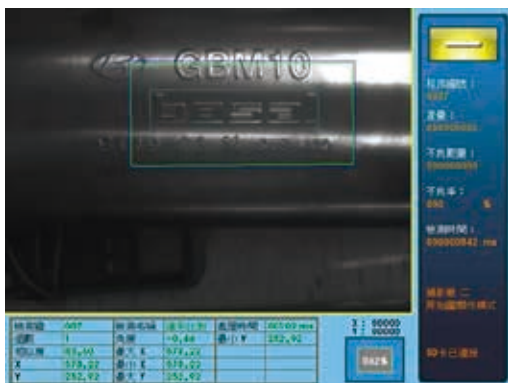

【Process】

- When a workpiece is sent to the inspection area, the DMV Series starts to take photos
- The DMV Series sends the OK/NG signals to the controller via I/O communication. If the result shows NG, the controller will trigger an output to alert operators

Advantages of the DMV system

The DMV Series effectively prevents incorrect feeding and reduces material waste

Rubber and Plastics



Inspection Objectives

Plastic bottle cap positioning

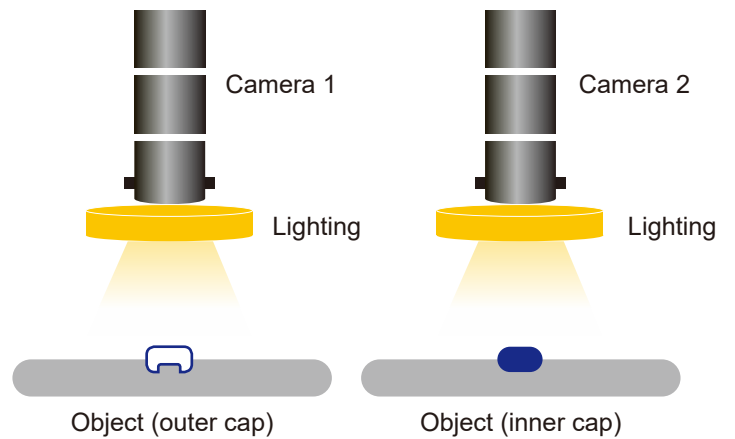

Device Configuration

Controller	DMV1000 (also applicable with DMV2000)
Camera	DMV-CD80GS
Lens	12 mm focal length
Illumination	White ring light, front lighting
Working distance	200 mm
FOV	80 mm x 60 mm

【 Inspecting Tool 】

Two cameras and the "Shape" function are used for this application to obtain the coordinates and the angle of the plastic cap

【 Key Point 】

Uses the white ring light for front lighting to receive better image quality

【Result】

- Inspection speed of inner and outer caps: within 230 ms
- After testing, the DMV Series is able to ensure the position angle difference of the outer and inner caps within 1 mm and 0.5 degree during assembly (customer's demand: less than 2 mm)

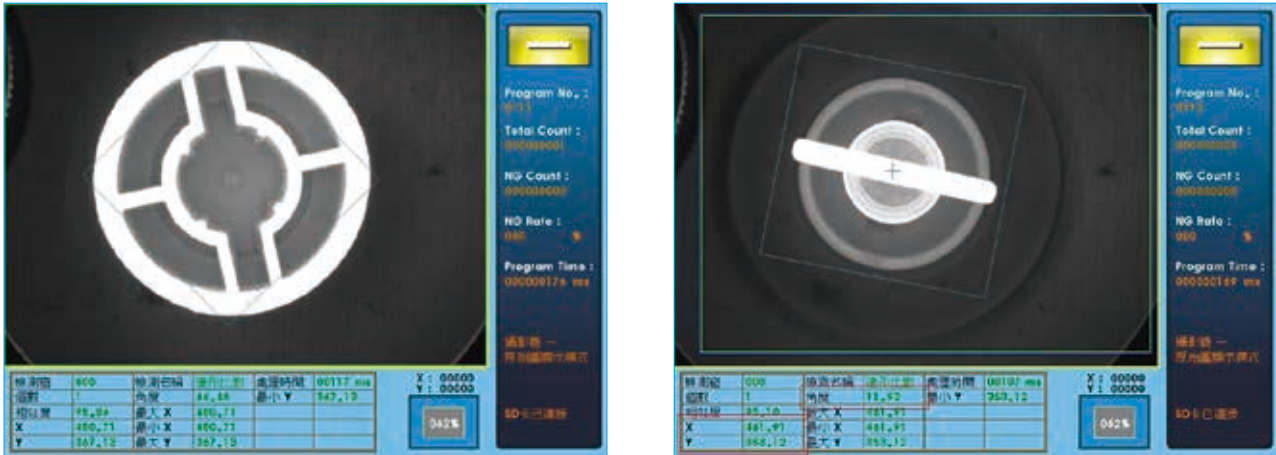

【Process】

- Uses 1 DMV controller with 2 cameras to capture images
- After camera 1 receives the coordinates and the angle of the outer cap, the robot will pick up the outer cap. Then camera 2 locates the coordinates of the inner cap, and the robot will assemble the outer cap to the inner cap according to the two detection results

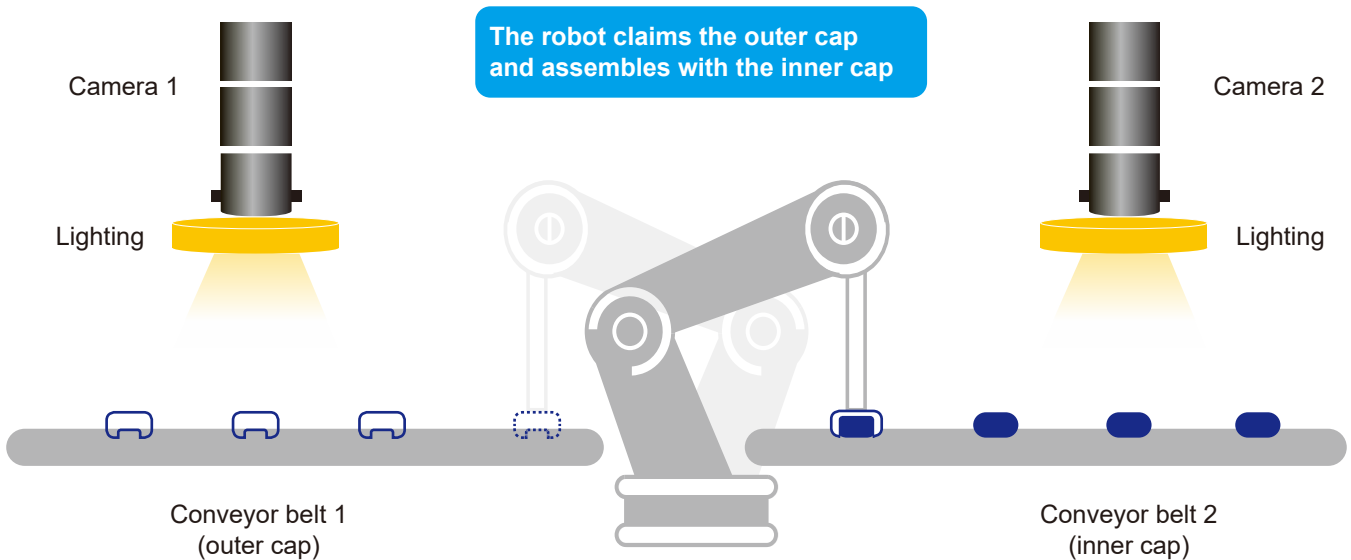

Advantages of the DMV system

The integration of the DMV Series and industrial robots effectively reduces labor cost

Rubber and Plastics



Inspection Objectives

Rubber washer inspection

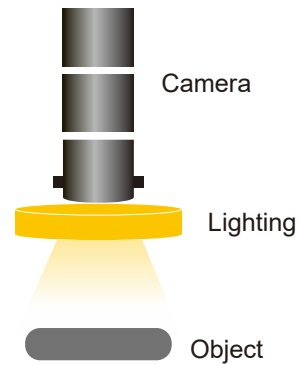

Device Configuration

Controller	DMV1000 (also applicable with DMV2000)
Camera	DMV-CD80GS
Lens	25 mm focal length
Illumination	Red ring light
Working distance	Approx. 208 mm
FOV	Approx. 40 mm x 30 mm

【 Inspecting Tool 】

- Use 2 "Edge Position" functions to locate the rim of the rubber gasket
- Then use 2 "Position Trace" functions to inspect whether the inner rim, outer rim and the whole rubber gasket meet the standard

【 Key Point 】

This application requires inspection of three parameters of a rubber gasket: the inner diameter, the outer diameter and the roundness

【Result】

- Inspection speed: within 200 ms
- Use the "Position Trace" function to scan the inner rim of the rubber gasket and check whether the radius and the roundness meet the standard
- Then use another "Position Trace" function to scan the outer rim of the rubber gasket and check whether the radius and the roundness meet the standard

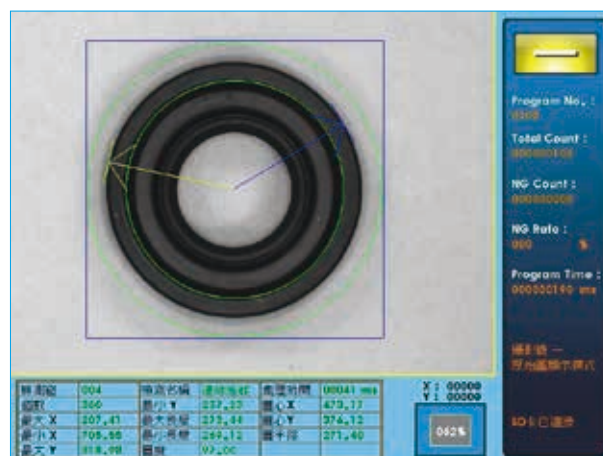
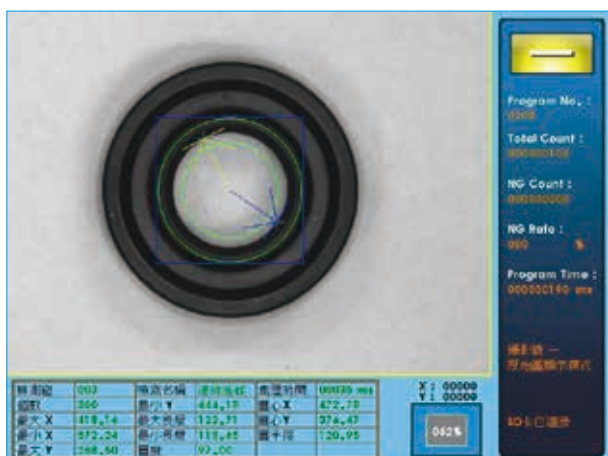

【Process】

- When the rubber gasket enters the inspection area, the DMV Series starts to capture images
- The DMV Series sends the OK/NG signals to the controller via I/O communication; if the result shows NG, the controller will send an order to remove the defective products

Advantages of the DMV system

The DMV Series enhances productivity and reduces the defect rate for manufacturers

Rubber and Plastics



Inspection Objectives

Inspection of self-tapping screw on a plastic workpiece



Device Configuration

Controller	DMV1000 (also applicable with DMV2000)
Camera	DMV-CD30GS
Lens	12 mm focal length
Illumination	Back light
Working distance	93 mm
FOV	40 mm x 30 mm

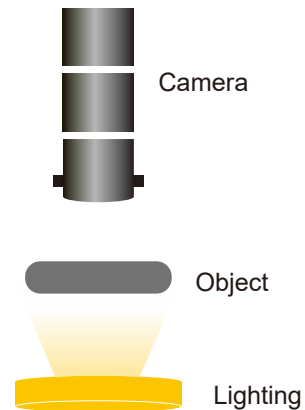

【 Inspecting Tool 】

Use the "Edge Position" function to inspect the height of a locked screw, and use the "Edge Angle" function to inspect whether the locked screw is tilted

【 Key Point 】

Acquire the clear screw outline with a back light to get the most precise results when measuring position and angles

【Result】

- Inspection speed: within 120 ms
- Inspecting the height and angle of the locked screw helps ensure the plastic workpiece is fixed on the furniture

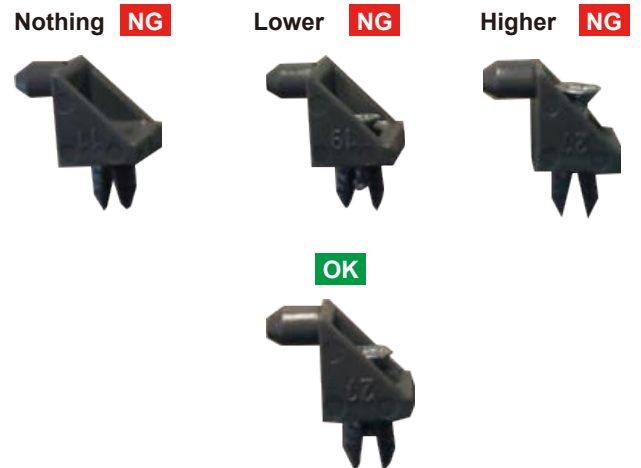
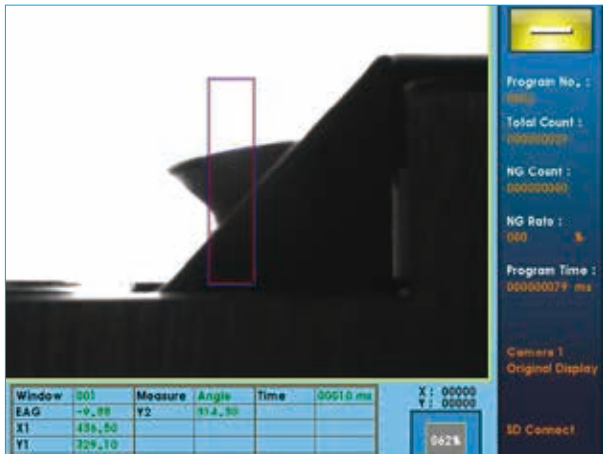

【Process】

The feeding plate sends the material to the detection area. With the sharp outline by back light, the system inspects the height and the angle of the locked screw

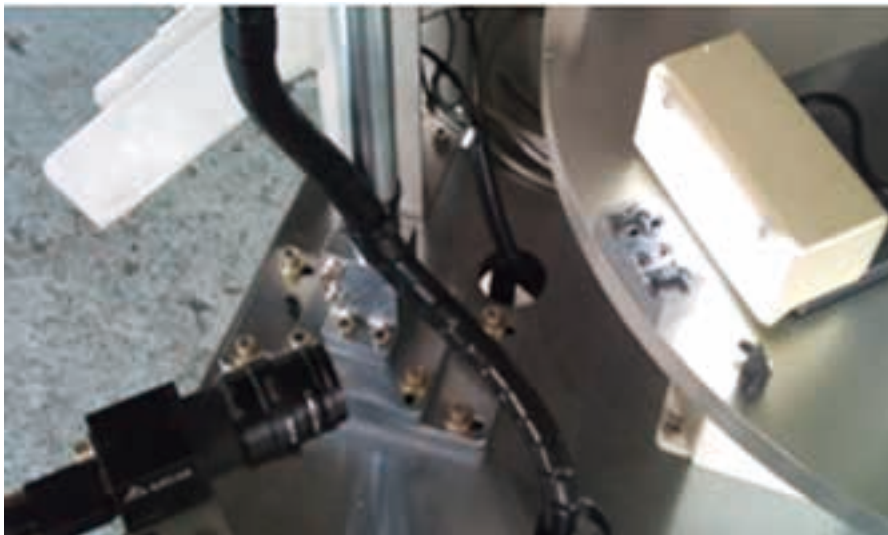

Advantages of the DMV system

This solution achieves high-speed inspection, enhancing production efficiency

Rubber and Plastics



Inspection Objectives

Plastic bottle and washer inspection

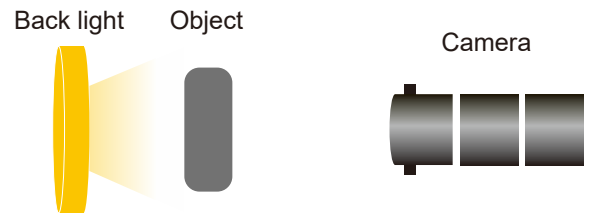

Device Configuration

Controller	DMV1000 (also applicable with DMV2000)
Camera	DMV-CD80GS
Lens	12 mm focal length
Illumination	White back light
Working distance	approx. 160 mm
FOV	approx. 65 mm x 49 mm

【 Inspecting Tool 】

- Use 2 "Edge Position" functions to position coordinates, and then use the "Area" function to confirm the presence of the cap
- Use the "Edge Width" function to inspect the fixing clip

【 Key Point 】

Use the back light to clearly contrast the bottle outline and enhance measuring precision

【Result】

- Inspection speed: within 150 ms; when the workpiece enters the inspection area, the DMV Series inspects whether the plastic cap and the fixing clip are present
- When the object enters the inspection area, the DMV Series uses the "Area" function to inspect whether the plastic cap and the fixing clip are installed; if the cap is there, the black area will be over 18,000 pixels

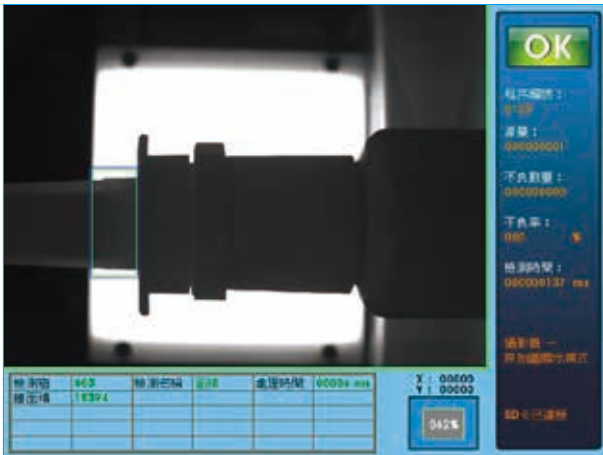

- Use the "Edge width" function to inspect the plastic clips; if a clip is present, the width value will be over 250 pixels

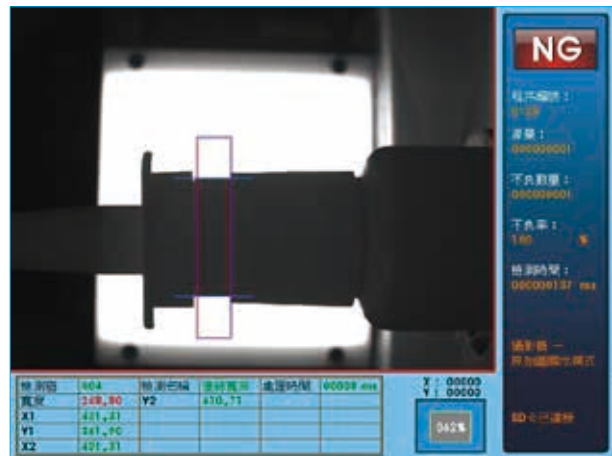
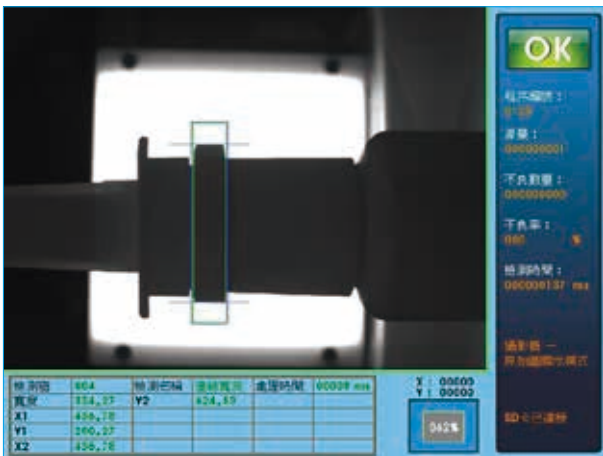

【Process】

- After the workpiece is sent to the inspection area, the DMV Series starts to capture images
- The DMV Series sends the OK/NG signals to the controller via I/O communication; if the result is NG, the controller will send a defect removal command

Advantages of the DMV system

The DMV Series can correctly inspect whether the plastic bottles are mis-installed or lack parts, reducing the defect rate

Packaging



Inspection Objectives

Package barcode inspection

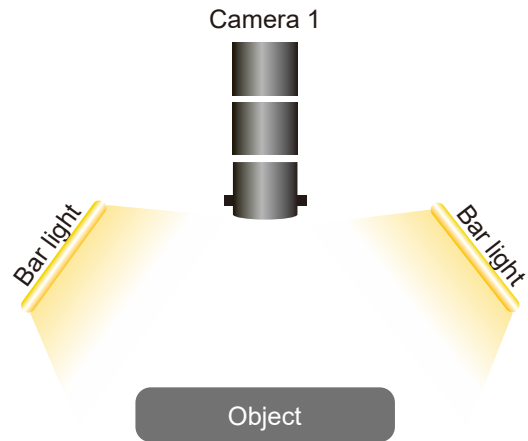

Device Configuration

Controller	DMV1000 (also applicable with DMV2000)
Camera	DMV-CD80GS
Lens	12 mm focal length
Illumination	White bar light *2
Working distance	Approx. 210 mm
FOV	Approx. 154 mm x 115.5 mm

【 Inspecting Tool 】

Use the "Shape" function to position the printed "Free Scan Now" characters, and then use the "Bar Code" function to scan the 1-D and the 2-D barcodes on the workpiece

【 Key Point 】

- The lighting needs to contrast the barcodes
- Positioning functions are suggested to prevent offset

【Result】

- Inspection speed: within 300 ms
- As soon as the barcode is scanned, the system will show the result



【Process】

- When a workpiece is sent to the inspection area, the DMV Series starts to capture images
- The DMV Series sends the OK/NG signals to the controller via I/O communication; if the result shows NG, the controller will trigger an output to alert operators

Advantages of the DMV system

The integration of the DMV Series greatly reduces the chance of incorrect printing and feeding

Packaging



Inspection Objectives

Coffee filter inspection

Use the DMV Series to inspect whether the number of coffee filters is correct. A normal product contains 1 filter; while a defect contains 2 or more, or no filters

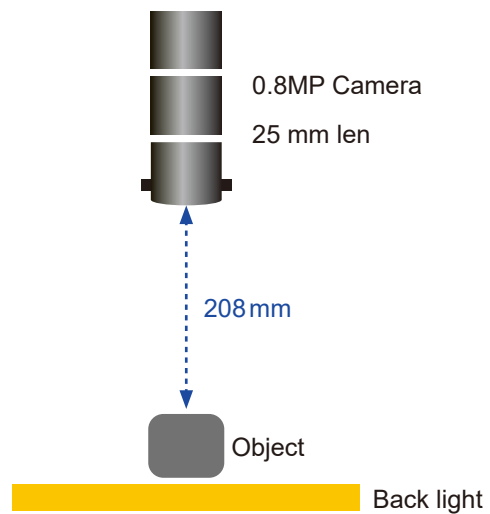
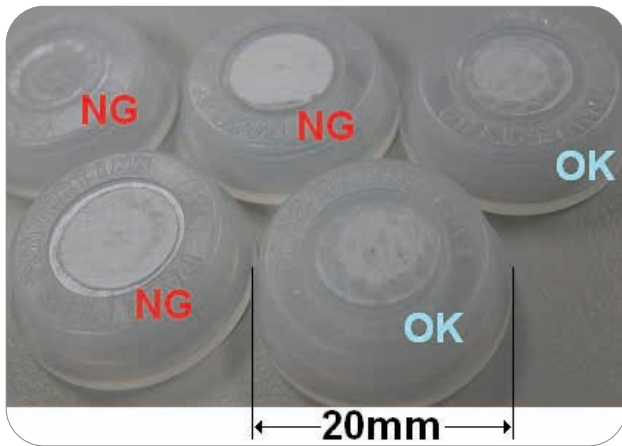

Device Configuration

Controller	DMV1000 (also applicable with DMV2000)
Camera	DMV-CD80GS
Lens	25 mm focal length
Illumination	Back light
Working distance	208 mm
FOV	40 mm x 30 mm

【 Inspecting Tool 】

Use the "Shape" function to position the coffee filter, and then use the "Intensity" function to inspect the number of the filters

【 Key Point 】

- The number of filters affects transparency, which is how the DMV Series determines the number of coffee filters
- A hollow-type conveyor is required for the back light to transmit through the back of the conveyor belt

【Result】

- The normal product contains only 1 filter, with an average image intensity of 165
- When it contains 2 filters, the average image intensity reduces to 132

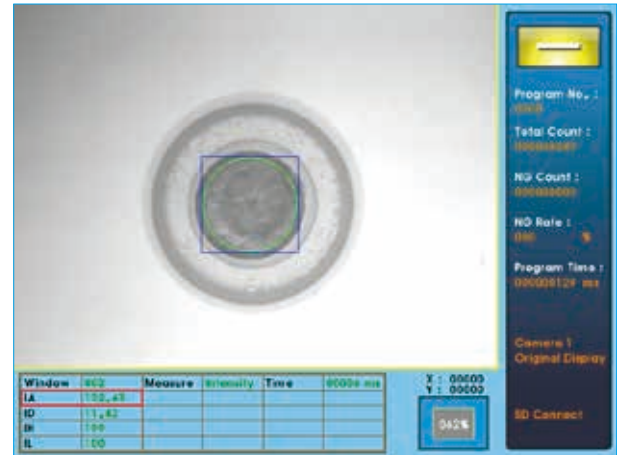

- When it contains no filters, the average image intensity goes up to 220



【Process】

The conveyor belt sends the coffee filters to the inspection area. The ones with the correct number of filters continue, and the ones with incorrect numbers or none are discarded

Advantages of the DMV system

This application fulfills the requirement for automatic inspection after assembly

Packaging



Inspection Objectives

Inspection of face mask outer packages

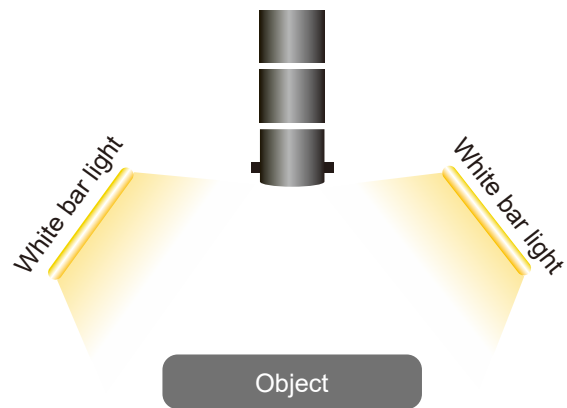

Device Configuration

Controller	DMV1000 (also applicable with DMV2000)
Camera	DMV-CD30GS
Lens	12 mm focal length
Illumination	white bar light x 2
Working distance	Approx. 383.3 mm
FOV	Approx. 153.3 mm x 115 mm

【Inspecting Tool】

- Use the "Shape" function to locate the position
- Then use 2 "Area" functions to check the manufactured dates and security label individually

【Key Point】

Using lighting on two sides effectively reduces deviant inspection of the outer package caused by glare

【Result】

- Inspection speed: within 150 ms
- When the workpiece enters the inspection area, the DMV Series will inspect the MFD and the security label printed on the outer package
- Using the "Area" function to check whether the outer package is printed with MFD
- The following figure shows the outer package without MFD and judged an NG product



- Using the "Area" function to check whether the outer package is printed with a security label (The figure is shown with a barcode label)
- The following figure shows the outer package without a security label and judged as an NG product (The figure is shown without a barcode label)



【Process】

- When the object enters the inspection area, the controller triggers the DMV Series to capture images
- The DMV Series will send OK/NG signals to the controller via I/O; if the result shows NG, the controller will remove the product

Advantages of the DMV system

The DMV Series fulfills the need for checking any mis-printings or misplaced stickers on the outer packages and reduces defective products

Packaging



Inspection Objectives

Cosmetic sprayer inspection

Use the DMV Series to confirm whether the number of steel balls in the sprayer is correct



Device Configuration

Controller	DMV1000 (also applicable with DMV2000)
Camera	DMV-CD30GS
Lens	25 mm focal length
Illumination	Back light
Working distance	208 mm
FOV	40 mm x 30 mm

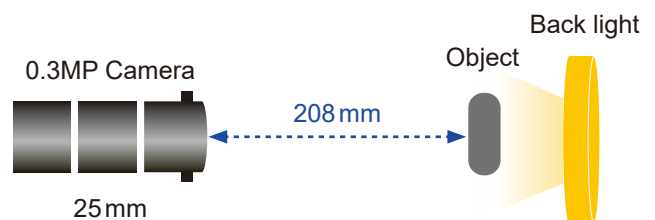

【 Inspecting Tool 】

Use the "Shape" function to position the sprayer, and then use the "Area" function to inspect the number of steel balls in the sprayer

【 Key Point 】

Use the back light to enhance contrast of the steel balls

【Result】

- When there is one steel ball, the black area is around 1,935 pixels, which is a normal value
- When there is no steel ball in the sprayer, the black area is around 345 pixels, which is an error value



- When there are 2 steel balls in the sprayer, the black area is around 2,662 pixels, which is an error value



【Process】

Place the sprayer onto the track and engage feeding via vibration. After the sprayer enters the inspection area, sensors trigger the DMV to capture images. If a defect is detected, the equipment is paused for rework; or the process continues if the detection result is OK

Advantages of the DMV system

This solution achieves automatic inspection after assembly

Printing



Inspection Objectives

Inspection of ink load for printing plates

Inspect whether ink insufficiency occurs in the ink area

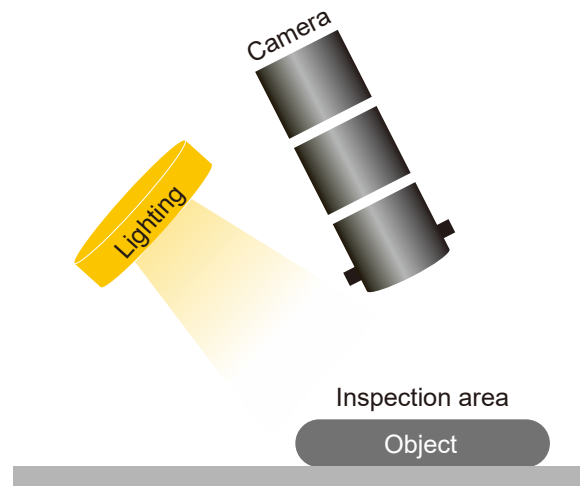
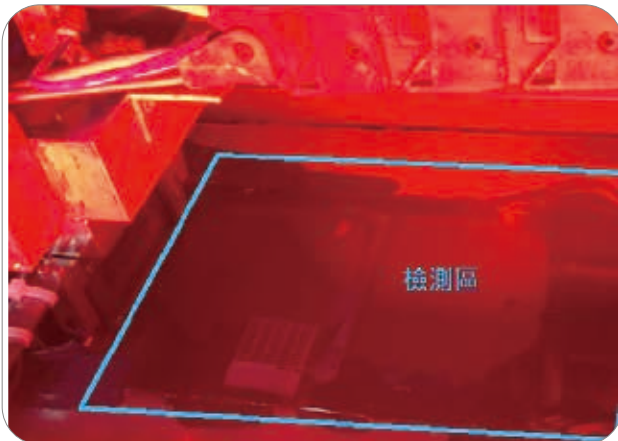

Device Configuration

Controller	DMV1000 (also applicable with DMV2000)
Camera	DMV-CD80GS
Lens	12 mm focal length
Illumination	backlight
Working distance	760 mm
FOV	300 mm x 225 mm

【Inspecting Tool】

Use the "Blob" function for inspection

【Key Point】

- While screening ink, the two sides of the squeegee contain less ink than the middle part, causing uneven ink distribution
- The DMV Series determines the ink load by inspecting printing quality

【Result】

Inspection speed: within 160 ms



【Process】

When the printing squeegee retreats, the DMV Series inspects the printing area to determine the ink load. If too many blobs are detected, the control system of the machine will judge the message as insufficient ink and trigger the auto ink refill process

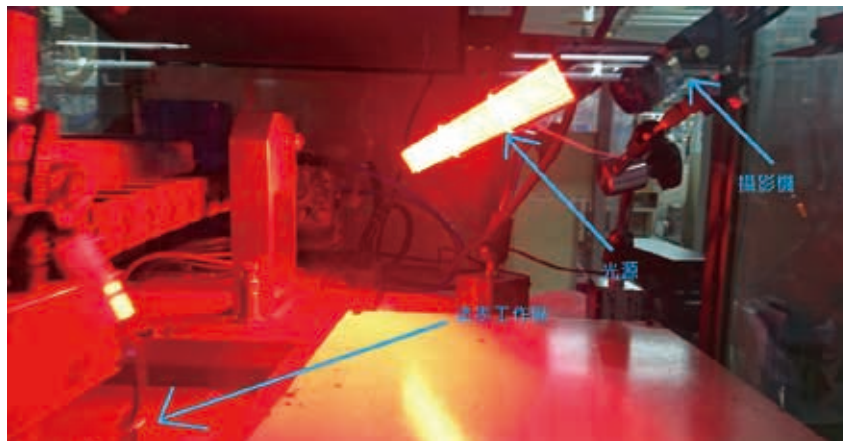

Advantages of the DMV system

The DMV Series detects the printing quality to determine insufficient ink load conditions, and informs the machine to reload ink by sending an alert, preventing printing defects

Printing



Inspection Objectives

Inspection of scratches on printed films

Inspect if there is any damage on the printed films (ex: light scratches)



Device Configuration

Controller	DMV1000 (also applicable with DMV2000)
Camera	DMV-CD80GS
Lens	6 mm focal length
Illumination	indoor lighting with fluorescent lamp, particular lighting not required
Working distance	450 mm
FOV	350 mm x 260 mm

【 Inspecting Tool 】

Use the "Edge Count" function to detect; if the DMV Series shows numbers in the result, it means scratches exist on the films

【 Key Point 】

- Since scratches are light-colored, use 3 "Edge Count " functions at the same time to precisely detect scratches on the printed films
- The printed film is thin and white, so a dark-colored background is suggested for contrasting scratches

【Result】

- Inspection speed: within 160 ms
- The DMV Series stably inspects scratches of approximately 0.3 mm or above

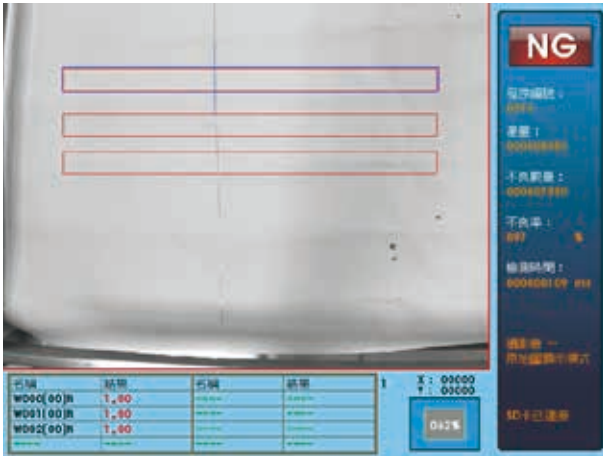

【Process】

When the DMV Series detects scratches, the result is delivered to the master controller via I/O communication, informing on-site personnel to troubleshoot

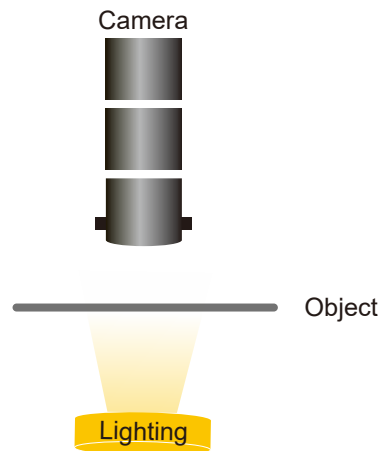

Advantages of the DMV system

In printing film manufacturing, human visual printing quality inspection is slow in speed and unstable in quality. The DMV Series helps achieve timely inspection to avoid massive printing defects

Printing



Inspection Objectives

Inspection of printing quality on metal workpiece

Inspect the gray circle printing area on the metal workpiece and identify if it contains any black/white spots or scratches

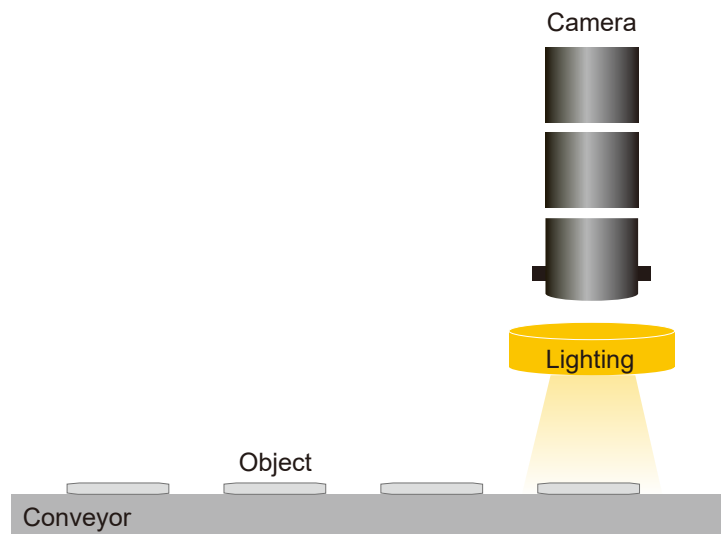
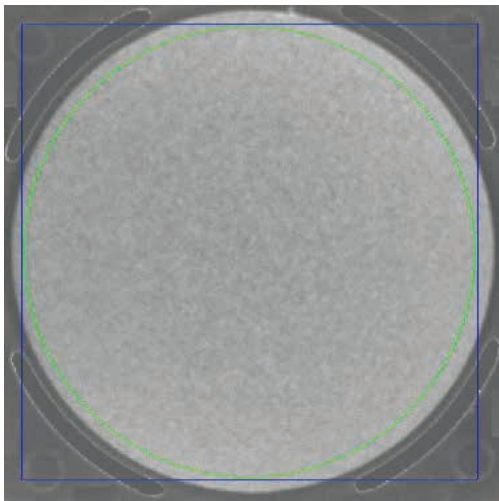

Device Configuration

Controller	DMV1000 (also applicable with DMV2000)
Camera	DMV-CD80GS
Lens	12 mm focal length + 1.5 mm extension ring
Illumination	White ring lighting at low angle
Working distance	70 mm
FOV	30 mm x 22 mm

【 Inspecting Tool 】

- Use the "Shape" function to position the metal workpiece
- Use the "Stain" function to track the circle area positioned by the previous "Shape" function; if any uneven image variation is inspected, it will be recognized as a stain

【 Key Point 】

The "Stain" function, matched with a low angle lighting for contrast, can easily identify stains on the printing surface

【Result】

- Inspection speed: within 170 ms
- The DMV Series can stably inspect stains of over 70 μm

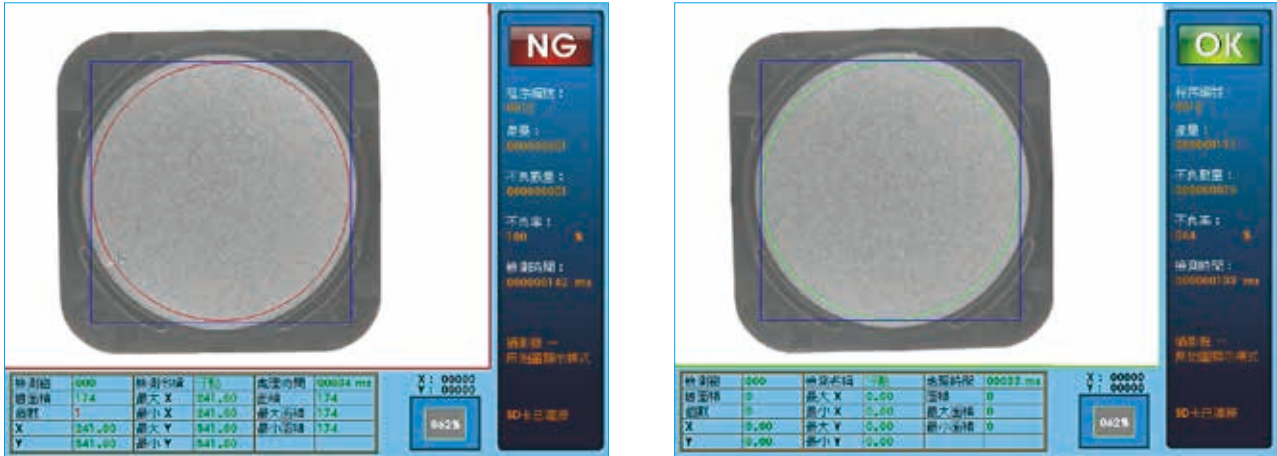

【Process】

Use servo motors to drive the ball screw for the feeding and positioning of each workpiece; When a workpiece enters the inspection area, the DMV system captures images via a camera for visual inspection, and identifies the printing quality of the workpiece

Advantages of the DMV system

Human visual inspection can be inadequate for examining minor stains, especially under long working hours and fatigue. The DMV Series allows users to self-define the stain size for inspection to achieve a stable, high-quality process, as well as to avoid inconsistent standards of human labor operation

Pharmaceuticals

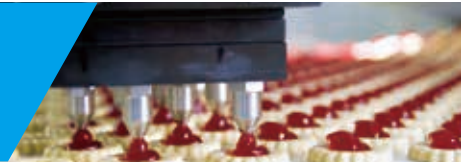

Inspection Objectives

Verification of expiration date (EXP) on medication bottles

Expiry Date

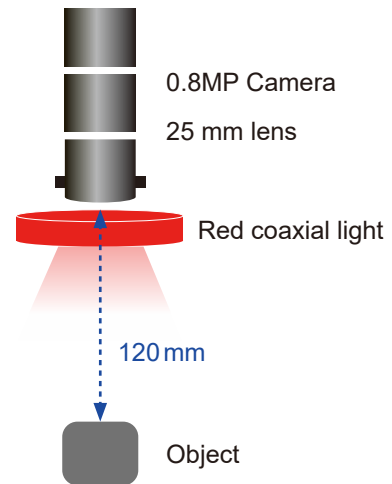

Device Configuration

Controller	DMV1000 (also applicable with DMV2000)
Camera	DMV-CD80GS
Lens	12 mm focal length
Illumination	Red coaxial light
Working distance	120 mm
FOV	50 mm x 38 mm

【 Inspecting Tool 】

Use the "Shape" function to locate specific wordings (e.g. LOT number or EXP printed on the measurand), then use the "Optical Character Verification (OCV)" function to identify the correctness

【 Key Point 】

The fonts of the laser-printed wordings on a medicine bottle may be inconsistent. To ensure inspection stability with the OCV function, apply a variety of character fonts in the DMV Series in advance to guarantee correct identification of the same wordings

【Result】

The following figure shows that the DMV Series successfully identified the EXP on the medicine bottle, which is 20181225



【Process】

After the DMV Series sends the inspection result to the controller, it will judge whether the EXP is correct or not.

Advantages of the DMV system

The DMV Series fulfills requirements for the auto-inspection of printed markings

Pharmaceuticals



Inspection Objectives

Tablet quality inspection

Use the DMV Series to inspect tablet quality, shape, and edge



Device Configuration

Controller	DMV2000		
Camera 1	DMV-CM30GCL	Camera 2	DMV-CM30GCL
Lens	16 mm focal length + 2 mm extension ring	Lens	16 mm focal length + 2 mm extension ring
Illumination	blue dome light	Illumination	Ring light at low angle
Working distance	89 mm	Working distance	89 mm
FOV	30 mm x 23 mm	FOV	30 mm x 23 mm

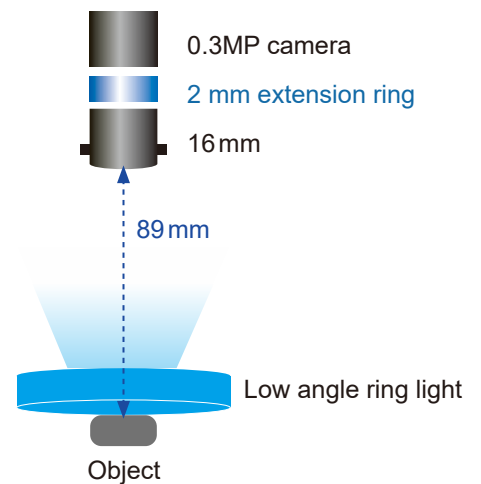
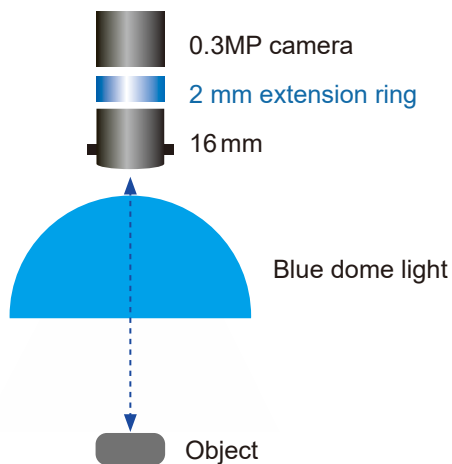

【Inspecting Tool】

- Use the "Shape" function to position tablets
- Use the "Blob" function to inspect stains on tablets
- Use the "Edge Count" function to inspect damaged edges and shapes of tablets

【Key Point】

- Use 2 cameras for inspection: one is matched with a blue dome light to inspect tablet stains, while the other is matched with a low angle ring light to inspect damaged edges and shapes of tablets
- Inspection speed is controlled within 72 ms, reaching an inspection efficiency of 400,000 tablets in 8 hours

【Result】

The DMV Series correctly inspects stains or damaged parts on each tablet within 30 ms

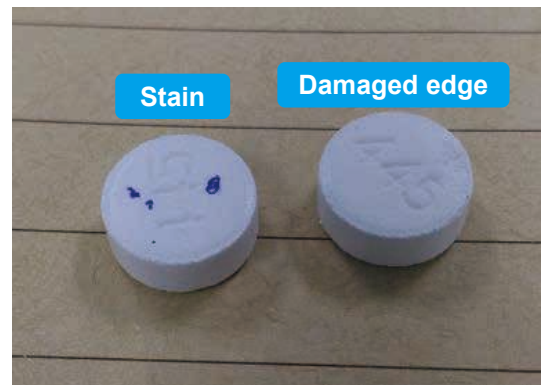

【Process】

When the tablets are sent to the inspection area, the sensor triggers the DMV 2000 Series for inspection. The qualified products will proceed, whereas the defective ones will be picked out

Advantages of the DMV system

The DMV2000 Series can replace human visual inspection to reduce the defect rate

Pharmaceuticals



Inspection Objectives

Inspection of tag position on medication packaging

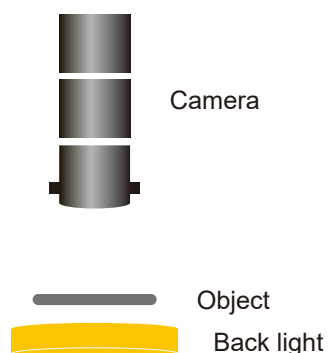

Device Configuration

Controller	DMV1000 (also applicable with DMV2000)
Camera	DMV-CD80GS
Lens	12mm focal length
Illumination	Back light
Working distance	160 mm
FOV	100 mm x 75 mm

【Inspecting Tool】

- Use the "Shape" function to position a roll of 5 transparent medication pods
- Use 5 "Area" functions to inspect the position of every label on the 5 pods

【Key Point】

- The DMV Series inspects stains and damage on the 5 labels within 72 ms
- Use 5 "Area" functions to inspect the labels' black area after the pods are positioned
- If the position of the medication pods is offset, the DMV Series automatically coordinates the pods based on the previous positioning

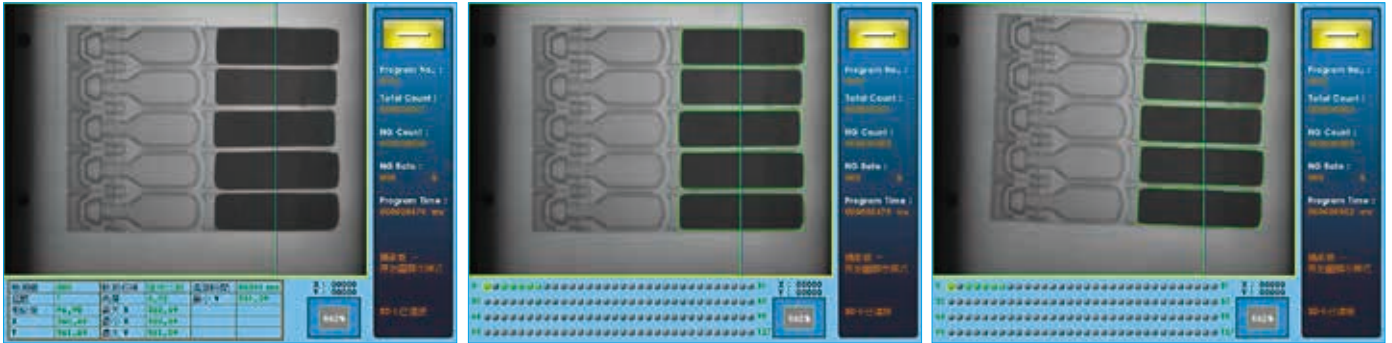

【Result】

- Inspection speed: within 600 ms
- The DMV Series achieves stable and correct inspection even when the pod position is offset

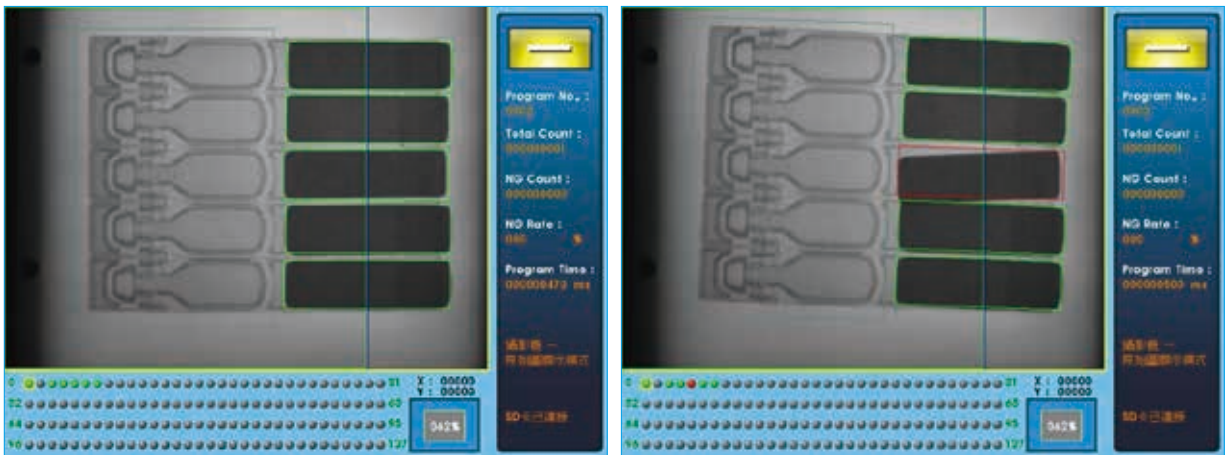

【Process】

Use a clamping device to pick up and place the workpiece on the feeding plate for inspection

Advantages of the DMV system

The DMV Series can replace human visual inspection to reduce the defect rate

Other



Inspection Objectives

Soldering spot coordinate identification on solar modules

Use the DMV Series to inspect the soldering spot coordinates according to the Y coordinate

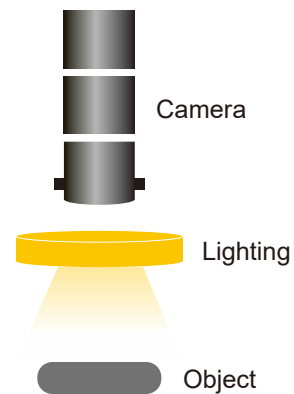
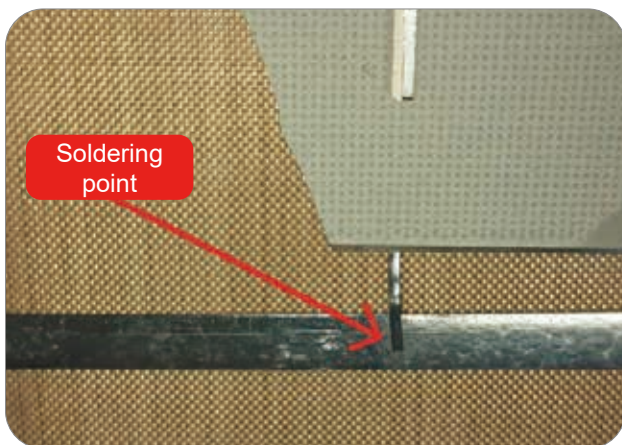

Device Configuration

Controller	DMV1000 (also applicable with DMV2000)
Camera	DMV-CD80GS
Lens	12 mm focal length
Illumination	white top ring light
Working distance	95 mm
FOV	40 mm x 30 mm

【 Inspecting Tool 】

Use 2 "Edge Position" functions to position the X-Y coordinates

【 Key Point 】

- Use the "Edge Position" functions to position the Y coordinate on the thick metal strip
- Then position the X coordinate on the thin metal strip with the Y coordinate as a reference

【Result】

- Inspection speed: within 200 ms / position precision: within 1 mm to fulfill inspection requirements of the 2-mm-width metal strip
- First, position the Y coordinate of the thick metal strip
- Then position the X coordinate on the thin metal strip according to the Y coordinate

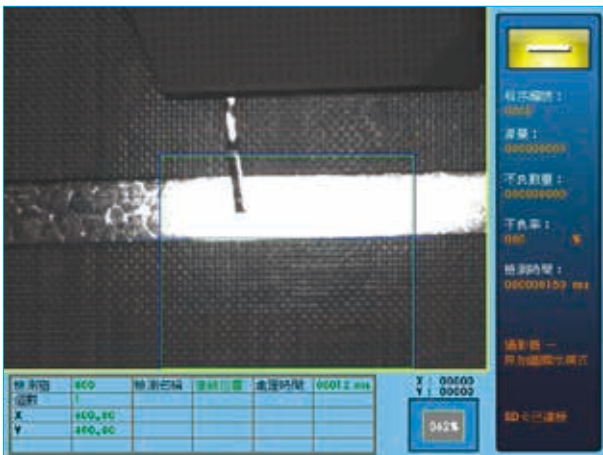

【Process】

Use the X-Y platform to coordinate the offset solar modules for precise soldering

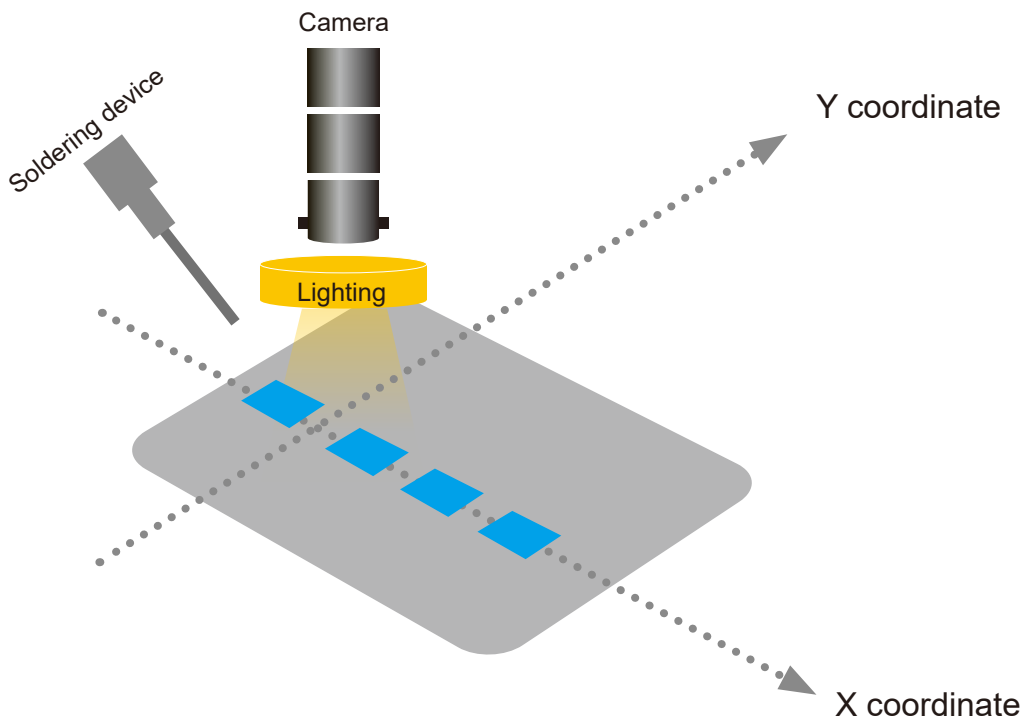

Advantages of the DMV system

The solar modules present a large area that is difficult for manual soldering. The DMV Series assists the automatic soldering process, and replaces workers to prevent labor health hazards

Other



Inspection Objectives

Metal rivet inspection

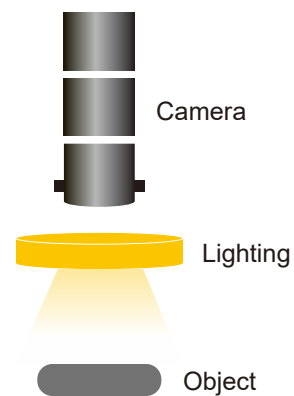

Device Configuration

Controller	DMV1000 (also applicable with DMV2000)
Camera	DMV-CD80GS
Lens	50 mm focal length + 10 mm extension ring
Illumination	White ring light
Working distance	180 mm
FOV	15 mm x 11 mm

【 Inspecting Tool 】

Use the "Area" function to inspect the black pixels and judge whether the workpiece contains a rivet inside

【 Key Point 】

- Because the metal workpiece is highly reflective, make sure the lighting is evenly cast during inspection
- A workpiece without a rivet shows a large area of white exposure under a proper lighting angle, whereas one with a rivet shows a shadow caused by light reflection. The DMV Series uses these differences to identify whether the workpiece contains a rivet

【Result】

- Inspection speed: within 150 ms
- The DMV Series stably and correctly inspects by recognizing an obvious contrast between presence / absence of a rivet
- When the workpiece contains a rivet, the black area value is 1,153 pixels as the system shows it as a good product (OK)
- When the workpiece contains no rivets, the black area value is 0 as the system shows it as an NG product

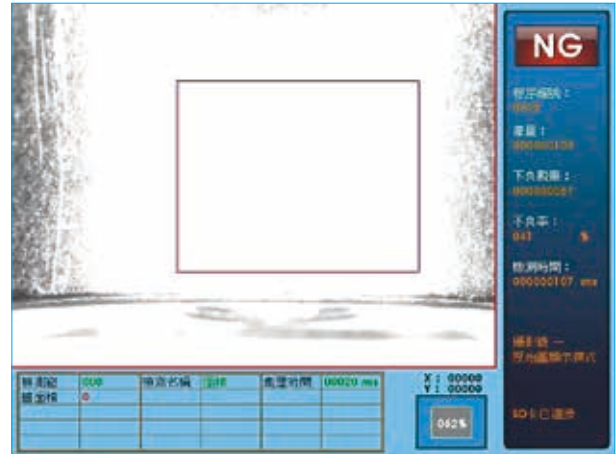

【Process】

The part feeder sends the workpiece to the rotary index table, and then the DMV Series inspects workpiece by workpiece; when the system shows NG, the product will be discarded at the next stop

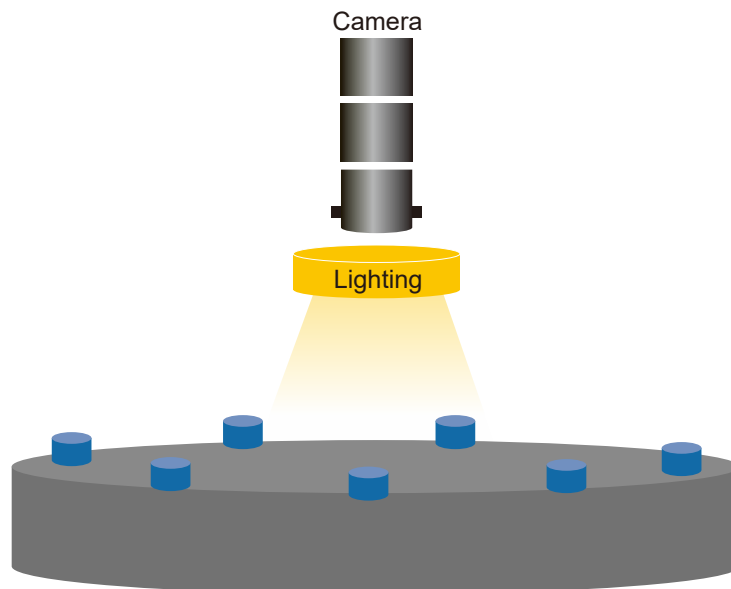

Advantages of the DMV system

Using the rotary index table during workpiece manufacturing, this application installs the DMV Series at one of the production stops to stably inspect the material quality. The DMV Series features high-speed inspection capabilities without affecting the overall production speed after installation on the production line, achieving a high-efficiency and stable machine vision application

Other

Inspection Objectives

Ceramic tile inspection

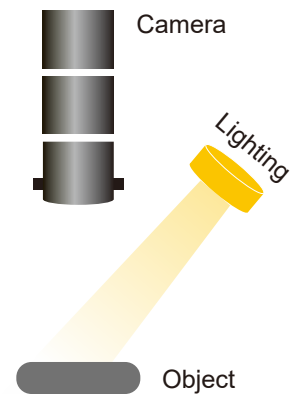

Device Configuration

Controller	DMV1000 (also applicable with DMV2000)
Camera	DMV-CD30GS
Lens	12 mm focal length
Illumination	White ring light, with side lighting
Working distance	180 mm
FOV	75 mm x 56 mm

【 Inspecting Tool 】

Use the "Edge Count" function to inspect the front and rear sides of the ceramic tile

【 Key Point 】

The front side of the ceramic tile is smooth and the rear side is grooved. The DMV Series uses the shadows caused by the grooved patterns to identify the front and rear sides of the ceramic tile

【Result】

- Inspection speed: within 130 ms
- The front and rear sides of the ceramic tiles are significantly different, resulting in stable and consistent inspection
- The "Edge Count" function shows the measurement is 0, meaning the ceramic tile is at the front side
- The "Edge Count" function shows the measurement is more than 0, meaning the ceramic tile is at the back side

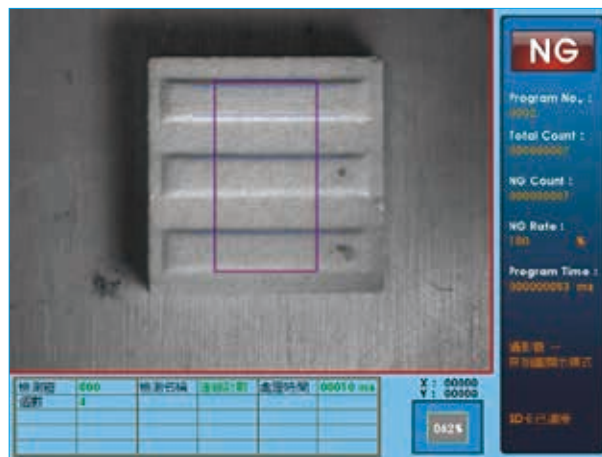

【Process】

The conveyor belt sends the ceramic tiles to the inspection area, and the sensor triggers the DMV Series to inspect; the rear sided tiles are blown away by air to ensure consistency

Advantages of the DMV system

Ceramic tiles are generally dusty, small and in large amounts. The DMV Series provides a faster and stabler scanning process and replaces manpower to prevent health hazards caused by dust

Other



Inspection Objectives

Inspection of the hollow direction on a metal workpiece

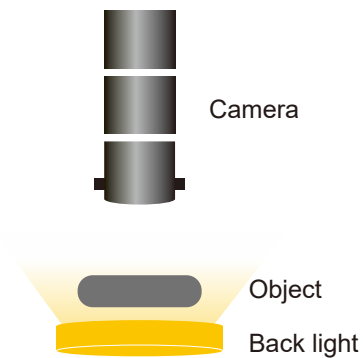

Device Configuration

Controller	DMV1000 (also applicable with DMV2000)
Camera	DMV-CD30GS
Lens	12 mm focal length
Illumination	Back light
Working distance	90 mm
FOV	40 mm x 30 mm

【 Inspecting Tool 】

- Use the 2 "Width Trace" functions to inspect the two ends of an iron pipe; the one with a smaller width value is the hollow side (right side)
- Then use the "Calculator" function to identify the hollow side of the iron pipe

【 Key Point 】

The "Width Trace" function is able to inspect the smallest width in the inspection area, without extra measurement tools

【Result】

- Inspection speed: within 120 ms
- Use the "Width Trace" function to inspect the left side of the iron pipe: the result shows the width is 118.64 pixels
- Use the "Width Trace" function again to inspect the right side of the iron pipe: the result shows the width is 110.40 pixels. The right width is smaller than the left width, meaning the iron hollow is at the right-hand side

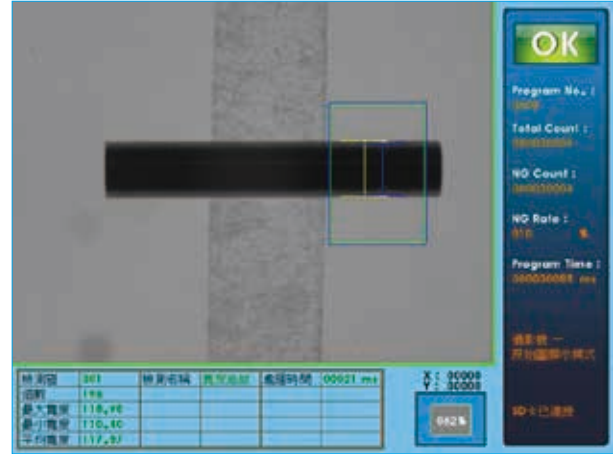
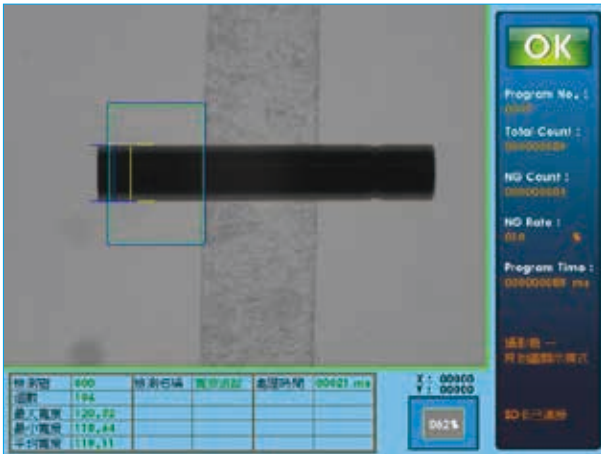

- With the above results, the "Calculator" function is able to identify the hollow side of the iron pipe

【Process】

The vibratory feeder sends the iron pipes to the index table, then the front camera inspects the hollow width of the iron pipe with back lighting to show the edge outline

Advantages of the DMV system

The hollow width of iron pipes is tiny, and it is hard for general inspection equipment to rapidly and precisely measure. The DMV Series is able to accomplish measurement and detection without damaging the iron pipes

Global Operations

ASIA (Taiwan)



Taoyuan Technology Center (Green Building)



Taoyuan Plant 1



Tainan Plant (Diamond-rated Green Building)



Wujiang Plant 3



Shanghai Office

ASIA (China)



ASIA (Japan)



Tokyo Office



ASIA (India)



Rudrapur Plant
(Green Building)

EUROPE



Amsterdam, the Netherlands

AMERICA



Research Triangle Park, U.S.A.

▲ 6 Factories ■ 117 Branch Offices ● 13 R&D Centers ■ 915 Distributors

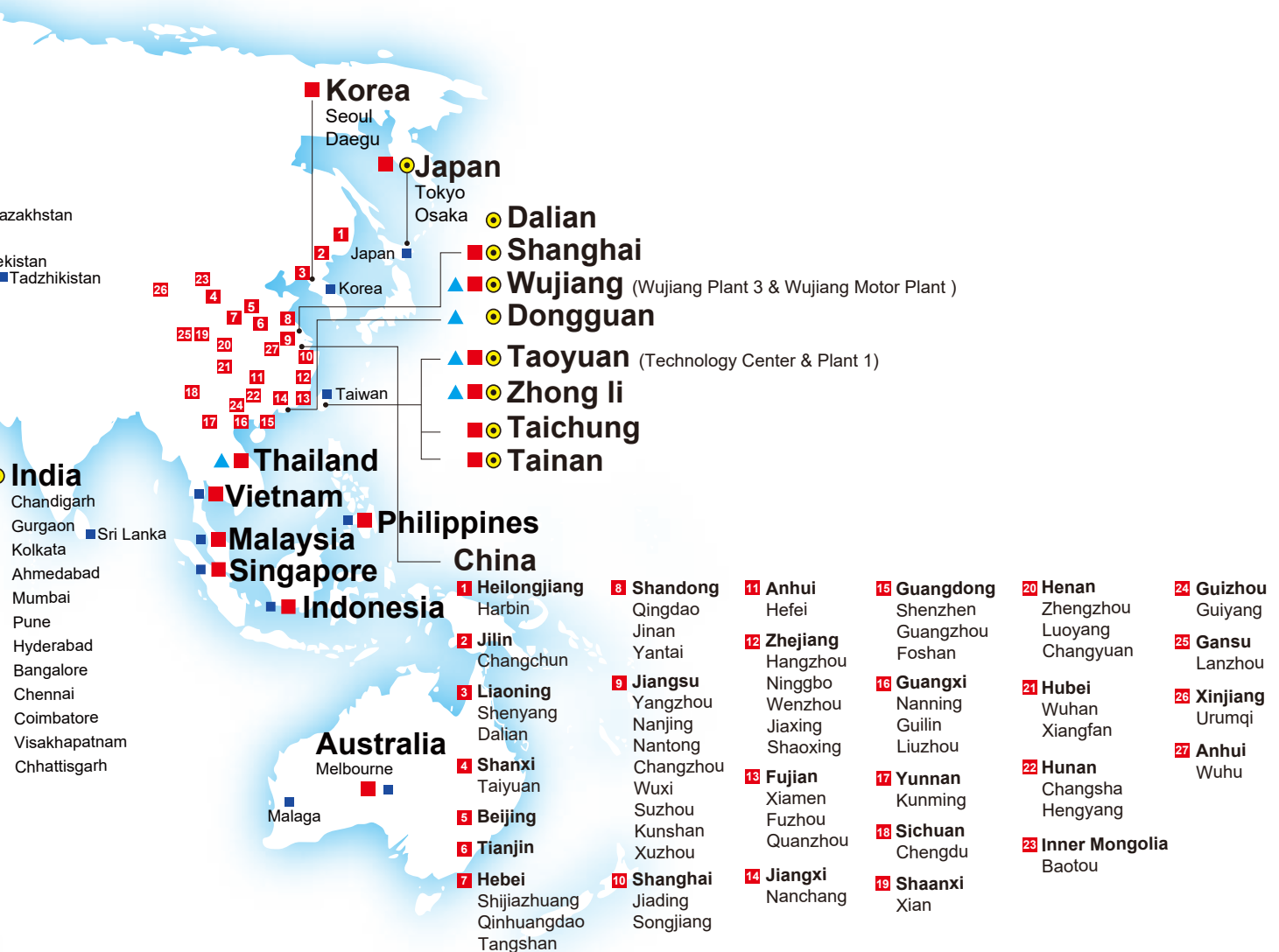



Smarter. Greener. Together.

Industrial Automation Headquarters

Delta Electronics, Inc.

Taoyuan Technology Center
No.18, Xinglong Rd., Taoyuan District,
Taoyuan City 33068, Taiwan
TEL: 886-3-362-6301 / FAX: 886-3-371-6301

Asia

Delta Electronics (Shanghai) Co., Ltd.

No.182 Minyu Rd., Pudong Shanghai, P.R.C.
Post code : 201209
TEL: 86-21-6872-3988 / FAX: 86-21-6872-3996
Customer Service: 400-820-9595

Delta Electronics (Japan), Inc.

Tokyo Office
Industrial Automation Sales Department
2-1-14 Shibadaimon, Minato-ku
Tokyo, Japan 105-0012
TEL: 81-3-5733-1155 / FAX: 81-3-5733-1255

Delta Electronics (Korea), Inc.

Seoul Office
1511, 219, Gasan Digital 1-Ro., Geumcheon-gu,
Seoul, 08501 South Korea
TEL: 82-2-515-5305 / FAX: 82-2-515-5302

Delta Energy Systems (Singapore) Pte Ltd.

4 Kaki Bukit Avenue 1, #05-04, Singapore 417939
TEL: 65-6747-5155 / FAX: 65-6744-9228

Delta Electronics (India) Pvt. Ltd.

Plot No.43, Sector 35, HSIIDC Gurgaon,
PIN 122001, Haryana, India
TEL: 91-124-4874900 / FAX : 91-124-4874945

Delta Electronics (Thailand) PCL.

909 Soi 9, Moo 4, Bangpoo Industrial Estate (E.P.Z),
Pattana 1 Rd., T.Phraksa, A.Muang,
Samutprakarn 10280, Thailand
TEL: 66-2709-2800 / FAX : 662-709-2827

Delta Electronics (Australia) Pty Ltd.

Unit 20-21/45 Normanby Rd., Notting Hill Vic 3168, Australia
TEL: 61-3-9543-3720

Americas

Delta Electronics (Americas) Ltd.

Raleigh Office
P.O. Box 12173, 5101 Davis Drive,
Research Triangle Park, NC 27709, U.S.A.
TEL: 1-919-767-3813 / FAX: 1-919-767-3969

Delta Electronics Brazil

São Paulo Sales Office
Rua Itapeva, 26 - 3º, andar Edifício Itapeva,
One - Bela Vista 01332-000 - São Paulo - SP - Brazil
TEL: 55-12-3932-2300 / FAX: 55-12-3932-237

Delta Electronics International Mexico S.A. de C.V.

Mexico Office
Gustavo Baz No. 309 Edificio E PB 103
Colonia La Loma, CP 54060
Tlalnepantla, Estado de México
TEL: 52-55-3603-9200

EMEA

Headquarters: Delta Electronics (Netherlands) B.V.

Sales: Sales.IA.EMEA@deltaww.com
Marketing: Marketing.IA.EMEA@deltaww.com
Technical Support: iatechnicalsupport@deltaww.com
Customer Support: Customer-Support@deltaww.com
Service: Service.IA.emea@deltaww.com
TEL: +31(0)40 800 3900

BENELUX: Delta Electronics (Netherlands) B.V.

De Witbogt 20, 5652 AG Eindhoven, The Netherlands
Mail: Sales.IA.Benelux@deltaww.com
TEL: +31(0)40 800 3900

DACH: Delta Electronics (Netherlands) B.V.

Coesterweg 45, D-59494 Soest, Germany
Mail: Sales.IA.DACH@deltaww.com
TEL: +49(0)2921 987 0

France: Delta Electronics (France) S.A.

ZI du bois Challand 2, 15 rue des Pyrénées,
Lisses, 91090 Evry Cedex, France
Mail: Sales.IA.FR@deltaww.com
TEL: +33(0)1 69 77 82 60

Iberia: Delta Electronics Solutions (Spain) S.L.U

Ctra. De Villaverde a Vallecas, 265 1º Dcha Ed.
Hormigueras – P.I. de Vallecas 28031 Madrid
TEL: +34(0)91 223 74 20

Carrer Llacuna 166, 08018 Barcelona, Spain

Mail: Sales.IA.Iberia@deltaww.com

Italy: Delta Electronics (Italy) S.r.l.

Via Meda 2-22060 Novedrate(CO)
Piazza Grazioli 18 00186 Roma Italy
Mail: Sales.IA.Italy@deltaww.com
TEL: +39 039 8900365

Russia: Delta Energy System LLC

Vereyskaya Plaza II, office 112 Vereyskaya str.
17 121357 Moscow Russia
Mail: Sales.IA.RU@deltaww.com
TEL: +7 495 644 3240

Turkey: Delta Greentech Elektronik San. Ltd. Sti. (Turkey)

Şerifaii Mah. Hendem Cad. Kule Sok. No:16-A
34775 Ümraniye – İstanbul
Mail: Sales.IA.Turkey@deltaww.com
TEL: + 90 216 499 9910

GCC: Delta Energy Systems AG (Dubai BR)

P.O. Box 185668, Gate 7, 3rd Floor, Hamarain Centre
Dubai, United Arab Emirates
Mail: Sales.IA.MEA@deltaww.com
TEL: +971(0)4 2690148

Egypt + North Africa: Delta Electronics

Unit 318, 3rd Floor, Trivium Business Complex, North 90 street,
New Cairo, Cairo, Egypt
Mail: Sales.IA.MEA@deltaww.com